

Operator's manual

**TruConvert DC 1030,
TruConvert System Control**

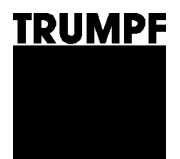

Operator's manual

**TruConvert DC 1030,
TruConvert System Control**

Original operator's manual

Edition **2022-06-22**

Order Information

Please specify when ordering this document:

Operator's manual

TruConvert DC 1030, TruConvert System Control

Edition 2022-06-22

Document number A67-0147-00.BKen-001-01

Address for orders

TRUMPF Hüttinger GmbH + Co. KG

Technische Redaktion

Bötzingen Straße 80

D-79111 Freiburg

Fon: +49 761 8971 - 0

Fax: +49 761 8971 - 1150

Internet: <http://www.trumpf-huettinger.com>

E-Mail: info.elektronik@de.trumpf.com

Good to know

Need help? Provide the **serial number** when you contact the Service department. The serial number can be found on the name plate of the device.

How to reach our Service department:

Telephone +49 761 8971-2170

Fax +49 761 8971-1178

E-mail Service.Elektronik@de.trumpf.com

Table of contents

1	Safety	4
1.1	Important notes	4
1.2	Storing the operating instructions	4
1.3	Warning signs	4
1.4	Using the DC-DC module	5
1.5	Authorized personnel	6
1.6	Warning signs on the DC-DC module	7
1.7	What you must know as an operator	7
1.8	Dangers from high voltages	8
	Protective measures taken by the manufacturer	9
1.9	What you must know as an operator	9
	Ensuring safe operation of the DC-DC module	9
	Check periodically	9
2	Description	10
2.1	Fields of application	10
	Typical fields of application	10
2.2	Function description	10
	Operation	12
2.3	Construction	13
	TruConvert DC series 1000 construction	13
	TruConvert System Control construction	14
2.4	Display elements	15
3	Technical specifications	16
3.1	TruConvert DC 1030 Data	16
3.2	TruConvert System Control data	22
4	Interfaces	24
4.1	Protective earth	24
4.2	Supply voltage 24 V DC	25
4.3	DC link connection and battery connection	25
4.4	RS-485 data input/data output (IN/OUT)	26
4.5	Interfaces on the system control	27
	24 V supply voltage (DC)	27



	Ethernet	28
	RS-485	28
5	Standards and directives	29
5.1	CE certification	29
5.2	EU declaration of conformity TruConvert DC 1030	30
5.3	EU declaration of conformity TruConvert System Control	31
6	Installation	32
6.1	Inspecting the delivery	32
6.2	Disposing of packaging material	32
6.3	Transport	32
6.4	Storage conditions	32
6.5	Requirements for the site	33
6.6	Possible installation positions	34
6.7	Electrical connection	35
	Establishing electrical connection	36
	Using ferrite core to achieve the limit value for level C1	39
	Connection diagram with 3 DC-DC modules (example)	40
6.8	Dismantling the DC-DC module	40
6.9	Shipping the module	41
6.10	Disposing of the module	41
7	Operation	42
7.1	Commissioning	42
	Performing initial commissioning	42
7.2	Active interface	47
7.3	Operation via web-based user interface	48
	Calling up the web GUI	48
	Orientation of the user interface	48
	Menu structure	52
7.4	Operation via Modbus	52
	Establishing a connection	53
	Addressing modules via Modbus	53
	Modbus Register Map	54
7.5	Transmission of power	60
	Switching the transmission of power on/off	60

7.6	Displaying and resetting messages	61
	Displaying messages of the web GUI	61
	Modbus: displaying and resetting messages	63
7.7	Overload	65
	Examples: Reduce and then again increase overload capacity	65
7.8	DC voltage droop	66
	Function description of DC voltage droop	66
	Switching on DC voltage droop	68
	Parameterization of DC voltage droop	68
7.9	Actual values	70
	Display actual values	70
7.10	Process set values	71
	Set process set values	71
7.11	Data backup	71
	Saving parameters and resetting to factory settings	71
7.12	System configuration	72
	Setting the system configuration	73
7.13	System settings	75
	Setting the system time	75
	Changing network settings	75
7.14	Software update	77
	Perform software update	77
7.15	Device information	77
	Displaying device information	77
7.16	State diagram	78
8	Maintenance	79
8.1	Periodic check of the environmental conditions	79
8.2	Cleaning	79
8.3	Exchanging fans	79
8.4	Performing software updates	79
9	Troubleshooting	80
9.1	Fault indication and messages	80
	Fault indication with the LEDs	80
9.2	Messages	80

1. Safety

1.1 Important notes

- This is a product for commercial and industrial use in the "second environment". This is the environment to which all commercial, light manufacturing and industrial enterprises belong, with the exception of those that are connected directly to the low-voltage network for the supply of buildings for residential use.
To prevent disturbances, restrictions regarding the installation or additional measures may be necessary.
- The products listed in the declaration of conformity are not independently operating products in the sense of the EMC directive. The EMC situation cannot be evaluated until the product has been incorporated in a complete system. The evaluation was verified for a typical system configuration, but not for the individual product.
- All technical safety requirements in the product-specific documentation (operating instructions, manual, etc.) must be adhered to throughout the entire product lifecycle.

1.2 Storing the operating instructions



IMPORTANT SAFETY INSTRUCTIONS

- SAVE THESE INSTRUCTIONS.
-

These operating instructions contain safety notices that must be observed during installation and maintenance. Therefore, keep the operating instructions in a safe place for the entire life cycle of the device.

Include the operating instructions if you sell the device or set it up at another location.

1.3 Warning signs

Certain activities can cause danger during operation. Corresponding warning signs concerning the dangers should precede instructions concerning the activities. Danger signs are located on the device.

A warning sign contains signal words which are explained in the following table:

Signal word	Description
DANGER	Indicates a major danger. If it is not avoided, serious injuries or death will result.
WARNING	Indicates a dangerous situation. If it is not avoided, it may lead to serious injuries.
CAUTION	Indicates a potentially dangerous situation. If it is not avoided, injuries may occur.
NOTICE	If such a situation is ignored, material damage may result.

Description of the signal words

Tab. 1

1.4 Using the DC-DC module

Typical fields of application

The DC-DC module is used as a link between a DC link and a DC voltage load or DC voltage source.

The DC voltage source can consist of a battery.

The energy can flow in either direction.

- The DC link voltage must be balanced to earth.
Deviations possible upon consultation with TRUMPF.
- Used batteries: All common rechargeable battery systems.
 - The DC-DC module may only be operated in combination with intrinsically safe batteries. The batteries must be connected in accordance with the applicable local standards. The relevant standards are DIN EN 50272-2, IEC62485, IEC61427-1 depending on the type of battery.
 - Maximum permissible voltage: 700 VDC.

Liability exclusion

Any use not listed under "Typical fields of application" contravenes the intended purpose. TRUMPF is not liable for any ensuing damages, in particular for property damage, personal injury and loss of production. The operator bears all risks. The warranty is rendered null and void.

Impermissible uses

Impermissible uses include, for example:

- Use of incorrect components.
- Operation on voltages outside the specification.
- Operation on DC link voltages which are not balanced to earth.
- Faulty installation (e.g., cables reversed).
- Use in unauthorized installation position.
- Misuse by untrained personnel.
- Input of wrong parameters.
- Use in unsuitable environmental conditions:
 - Condensation, icing.
 - Conductive soiling.
 - Corrosive conditions (e.g. battery fumes, salt spray).

-
- Voltages outside overvoltage category III (impulse withstand voltage of max. 4 kV).
 - Operation at more than 2000 m above sea level.
 - Operation outdoors.
 - Failure to observe "pollution degree 2" environmental condition.
 - Operation in an explosive environment.
 - Operation with non-intrinsically safe batteries.

1.5 Authorized personnel

Installation, operation, configuration and maintenance work may only be performed by authorized, trained and instructed personnel.

Authorized persons must be trained and be familiar with the standards and regulations relevant to their tasks.

It is the duty and responsibility of the operator to maintain the qualifications of the authorized personnel. The authorized personnel must therefore be trained at regular intervals.

The following activities may only be performed by authorized persons:

- Setting up the DC-DC module.
- Connecting the DC-DC module.
- Commissioning the DC-DC module.
- Dismantling the DC-DC module.
- Operating the DC-DC module.

1.6 Warning signs on the DC-DC module

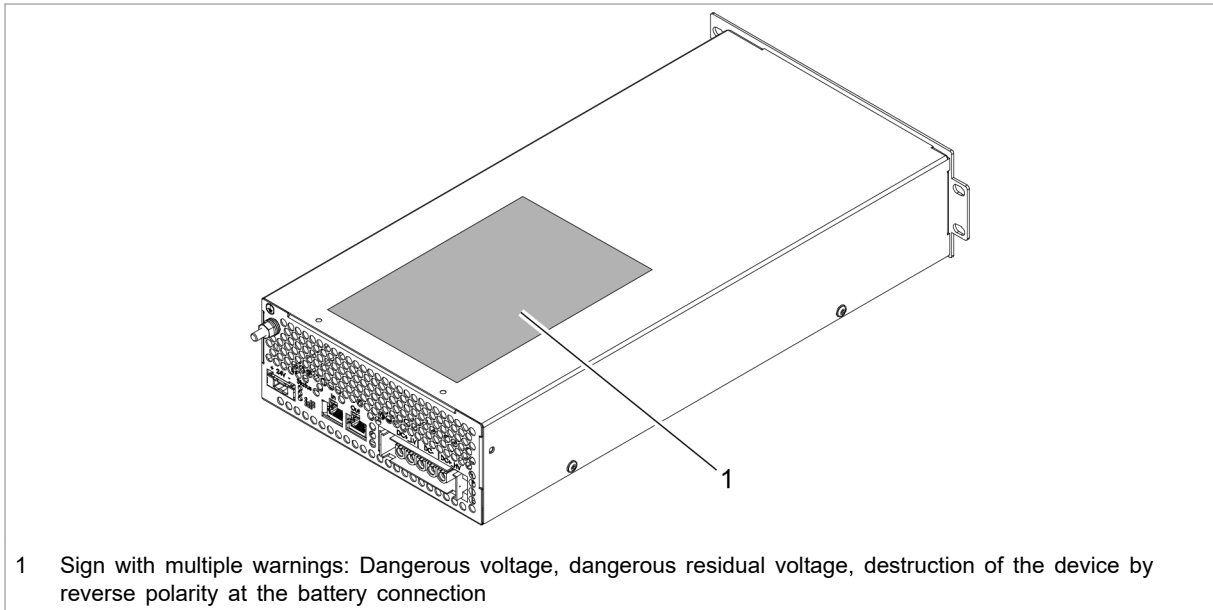

Warning signs on the DC-DC module







Fig. 1



1.7 What you must know as an operator

Note

All warning signs must be present and legible.

If one or more of these warning signs is missing or not legible, contact TRUMPF to request new warning signs.

Warning sign	Meaning					
	This sign indicates that the operating instructions must be read.					
<table border="1"> <tr> <td style="background-color: #FFC000; color: black; text-align: center;">⚠ WARNING</td> <td rowspan="2" style="text-align: center;">  </td> <td style="background-color: #FFC000; color: black; text-align: center;">⚠ AVERTISSEMENT</td> </tr> <tr> <td> HAZARDOUS VOLTAGE Contact may cause electric shock or burn. Do not remove cover. Turn off and lock out system before servicing. </td> <td> TENSION DANGEREUSE Le contact peut provoquer un choc électrique ou des brûlures. Ne pas retirer le couvercle. Couper et sécuriser l'alimentation électrique avant toute maintenance. </td> </tr> </table>	⚠ WARNING		⚠ AVERTISSEMENT	HAZARDOUS VOLTAGE Contact may cause electric shock or burn. Do not remove cover. Turn off and lock out system before servicing.	TENSION DANGEREUSE Le contact peut provoquer un choc électrique ou des brûlures. Ne pas retirer le couvercle. Couper et sécuriser l'alimentation électrique avant toute maintenance.	Sign warns of hazardous voltage.
⚠ WARNING			⚠ AVERTISSEMENT			
HAZARDOUS VOLTAGE Contact may cause electric shock or burn. Do not remove cover. Turn off and lock out system before servicing.		TENSION DANGEREUSE Le contact peut provoquer un choc électrique ou des brûlures. Ne pas retirer le couvercle. Couper et sécuriser l'alimentation électrique avant toute maintenance.				
<table border="1"> <tr> <td style="background-color: #FFC000; color: black; text-align: center;">⚠ WARNING</td> <td rowspan="2" style="text-align: center;">  </td> <td style="background-color: #FFC000; color: black; text-align: center;">⚠ AVERTISSEMENT</td> </tr> <tr> <td> HAZARDOUS RESIDUAL VOLTAGE Residual voltage remains in the system after disconnection of battery voltage. Discharge time to 60 V: 3 minutes. Wait until the system has discharged before servicing. </td> <td> TENSION RESIDUELLE DANGEREUSE Une tension résiduelle reste dans le système après le débranchement de la tension de la batterie. Temps de décharge jusqu'à 60 V: 3 minutes. Attendre que le système soit déchargé avant toute maintenance. </td> </tr> </table>	⚠ WARNING		⚠ AVERTISSEMENT	HAZARDOUS RESIDUAL VOLTAGE Residual voltage remains in the system after disconnection of battery voltage. Discharge time to 60 V: 3 minutes. Wait until the system has discharged before servicing.	TENSION RESIDUELLE DANGEREUSE Une tension résiduelle reste dans le système après le débranchement de la tension de la batterie. Temps de décharge jusqu'à 60 V: 3 minutes. Attendre que le système soit déchargé avant toute maintenance.	Sign warns of hazardous residual voltage.
⚠ WARNING			⚠ AVERTISSEMENT			
HAZARDOUS RESIDUAL VOLTAGE Residual voltage remains in the system after disconnection of battery voltage. Discharge time to 60 V: 3 minutes. Wait until the system has discharged before servicing.		TENSION RESIDUELLE DANGEREUSE Une tension résiduelle reste dans le système après le débranchement de la tension de la batterie. Temps de décharge jusqu'à 60 V: 3 minutes. Attendre que le système soit déchargé avant toute maintenance.				

Warning sign			Meaning
<p>CAUTION</p> <p>DESTRUCTION OF DEVICE Destruction of the device by reverse polarity at the battery connection. Observe the pole designation (+ and -). After polarity reversal: Do not switch on the device again. Danger of fire!</p>		<p>ATTENTION</p> <p>DESTRUCTION DE L'APPAREIL Destruction de l'appareil en cas d'inversion de la polarité du raccordement de la batterie. Tenir compte des repères des pôles (+ et -). S'il y a inversion de polarité : ne pas réenclencher l'appareil. Danger d'incendie !</p>	<p>Sign warns of destruction of the device by reverse polarity at the battery connection.</p>
<p>WARNING</p> <p>HAZARDOUS VOLTAGE Disconnect battery voltage before opening this cover.</p>		<p>AVERTISSEMENT</p> <p>TENSION DANGEREUSE Débrancher la tension de la batterie avant d'ouvrir ce couvercle.</p>	

Meaning of the warning signs

Tab. 2

1.8 Dangers from high voltages



Life threatening voltage!

The voltages present at the DC-DC module are life-threatening.

- Only have work on the DC-DC module performed by authorized, trained and instructed personnel.

The DC-DC module produces voltages that can endanger human life and health. These voltages occur both in the DC-DC module as well as at the outputs of the DC-DC module.

The DC-DC module's connection cables carry voltages that are life-threatening.

A person who comes into contact with live DC-DC module parts may be killed or severely injured.



Simultaneous control via web-based user interface and Modbus is possible!

Power transmission stopped using the user interface can be started again and reversed via Modbus.

- Before carrying out work on the device, deenergize all supply lines and secure against reenergizing.
- Make sure that the device is controlled via one channel only (user interface or Modbus).

Protective measures taken by the manufacturer

The DC-DC module is installed in an enclosed metal casing.

1.9 What you must know as an operator

Ensuring safe operation of the DC-DC module

1. The DC-DC module must not be opened.
There are no parts within the DC-DC module that can be serviced by the user.
2. Only operate the DC-DC module within the conditions described in chapter "Technical specifications".
3. For the electrical connection, use only cables that are in perfect condition and have the correct dimensions.

Check periodically

- Periodically retest acc. to DGUV regulation 3 (DGUV = Deutsche Gesetzliche Unfallversicherung – German Statutory Accident Insurance Association).

2. Description

2.1 Fields of application

Typical fields of application

Typical fields of application

The DC-DC module is used as a link between a DC link and a DC voltage load or DC voltage source.

The DC voltage source can consist of a battery.

The energy can flow in either direction.

- The DC link voltage should be balanced to earth. For permissible deviations, see (see "DC link (high-voltage side)", pg. 16).
- Used batteries: All common rechargeable battery systems.
 - The DC-DC module may only be operated in combination with intrinsically safe batteries. The batteries must be connected in accordance with the applicable local standards. The relevant standards are DIN EN 50272-2, IEC62485, IEC61427-1 depending on the type of battery.
 - Maximum permitted voltage:
 - Low-voltage side: ≤ 700 VDC.
 - High-voltage side: ≤ 950 VDC.
 - Allowed voltage range:
 - Low-voltage side: 100 VDC – 700 VDC.
 - High-voltage side: 150 VDC – 950 VDC.
 - Redox flow application: 0 ... 100 VDC, possible with reduced current.

NOTICE

Destruction of the device.

If the voltage on the low-voltage side is higher than the voltage on the high-voltage side, there is a risk of current flowing in an uncontrolled manner.

- Make sure that the voltage on the high-voltage side is at least 50 VDC higher than the voltage on the low-voltage side.

Control

The **TruConvert System Control** external control must be used to monitor and control the DC-DC module.

2.2 Function description

The DC-DC module is a bidirectional DC voltage converter for charging a battery from a DC link (high voltage) and for feeding energy from a battery back into the DC link (high voltage).

Voltage limits can be set both for the battery charging and discharging processes as is appropriate for the batteries used.

Note

Instead of a battery, a different DC energy source or DC load can also be used. For the sake of simplicity, we always speak of batteries in these operating instructions.

The device is air-cooled and transformerless. It does **not** come with galvanic isolation.

- Operation modes**
- The DC-DC module draws energy from a DC link (high voltage) and charges a battery.
 - The DC-DC module draws energy from a battery and feeds it into a DC link (high voltage).

Configurations

System control	Device Level 1	Device Level 2
TruConvert System Control	n × TruConvert DC 1030	–
TruConvert System Control	n × TruConvert DC 1008	–
TruConvert System Control	TruConvert AC 3025	m × TruConvert DC 1030
TruConvert System Control	TruConvert AC 3025	m × TruConvert DC 1008

n ≤ 16 pieces, m ≤ 4 pieces

Combination possibilities of the TruConvert devices

Tab. 3

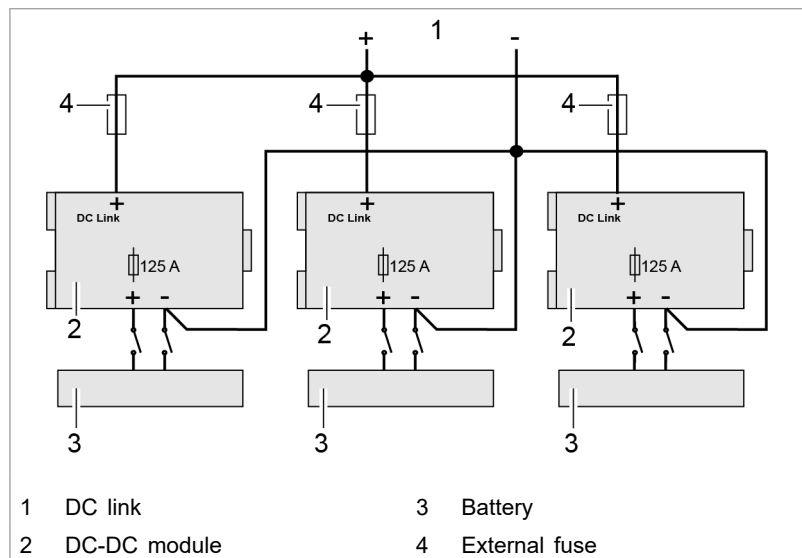

Single connection on battery side

Fig. 2

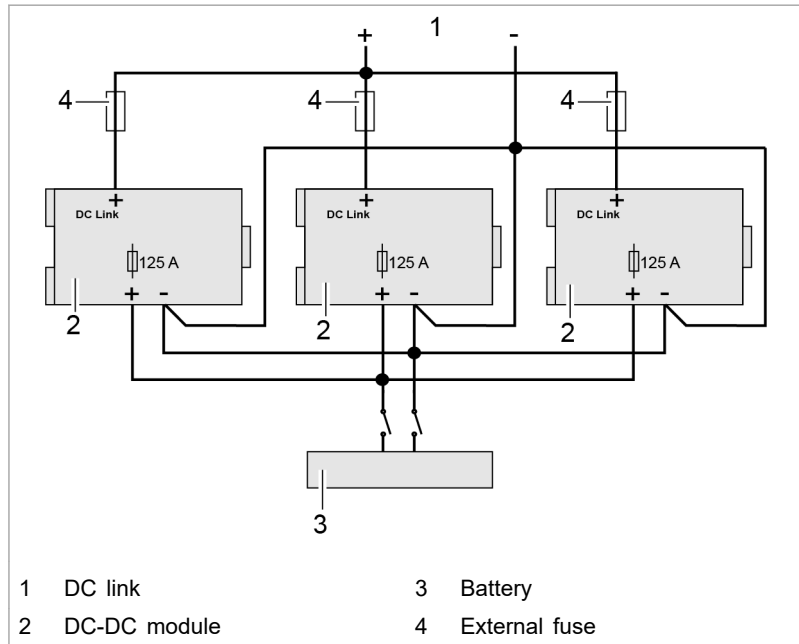

Parallel operation of battery side

Fig. 3

Operation

The DC-DC module can be operated via:

- PC with a web browser
- Modbus TCP/UDP

In both cases, the TruConvert System Control must be connected upstream. In the "DC only" configuration, a TruConvert System Control can control up to 16 DC-DC modules (see "Fig. 4", pg. 13).

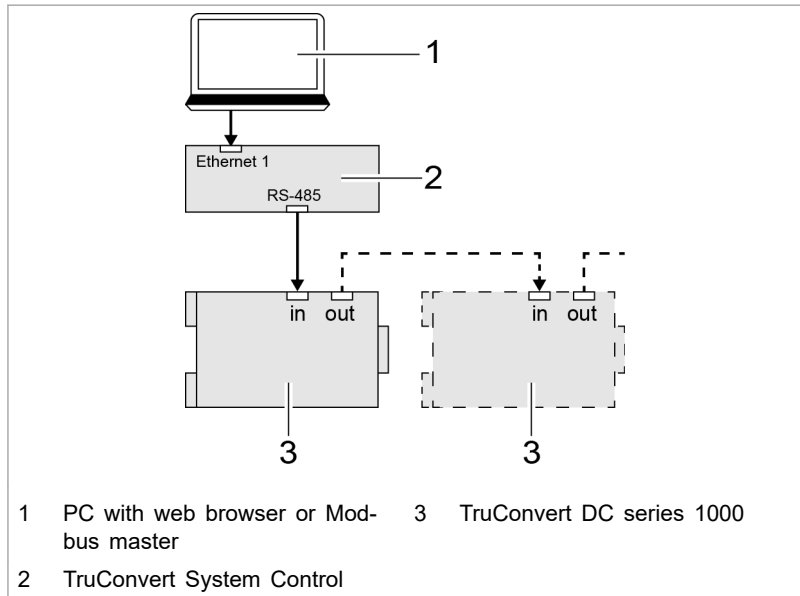

Operation with TruConvert System Control

Fig. 4

2.3 Construction

TruConvert DC series 1000 construction

Overview The DC-DC module is housed in an enclosed metal housing. The fan on the inside of the front panel draws in air for cooling. All connecting elements are located on the back side.

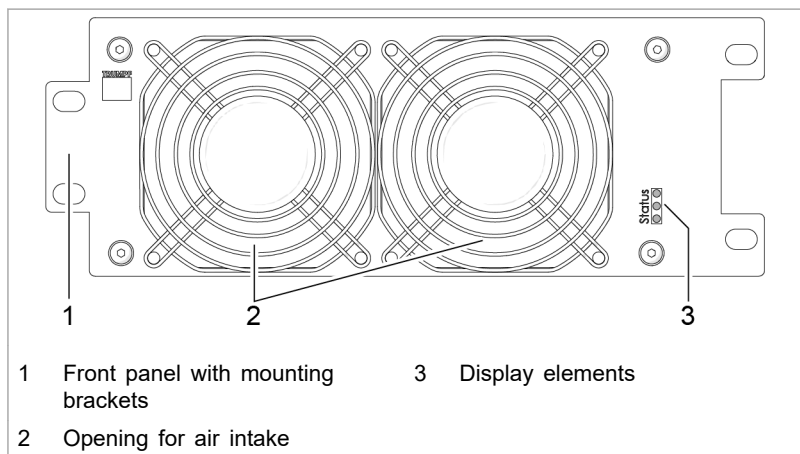

Overview

Fig. 5

Rear side

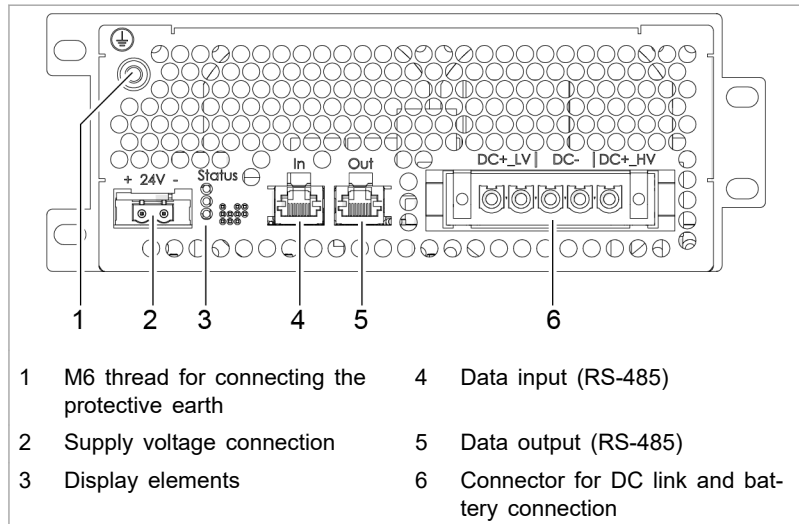

Rear side

Fig. 6

TruConvert System Control construction

Front side

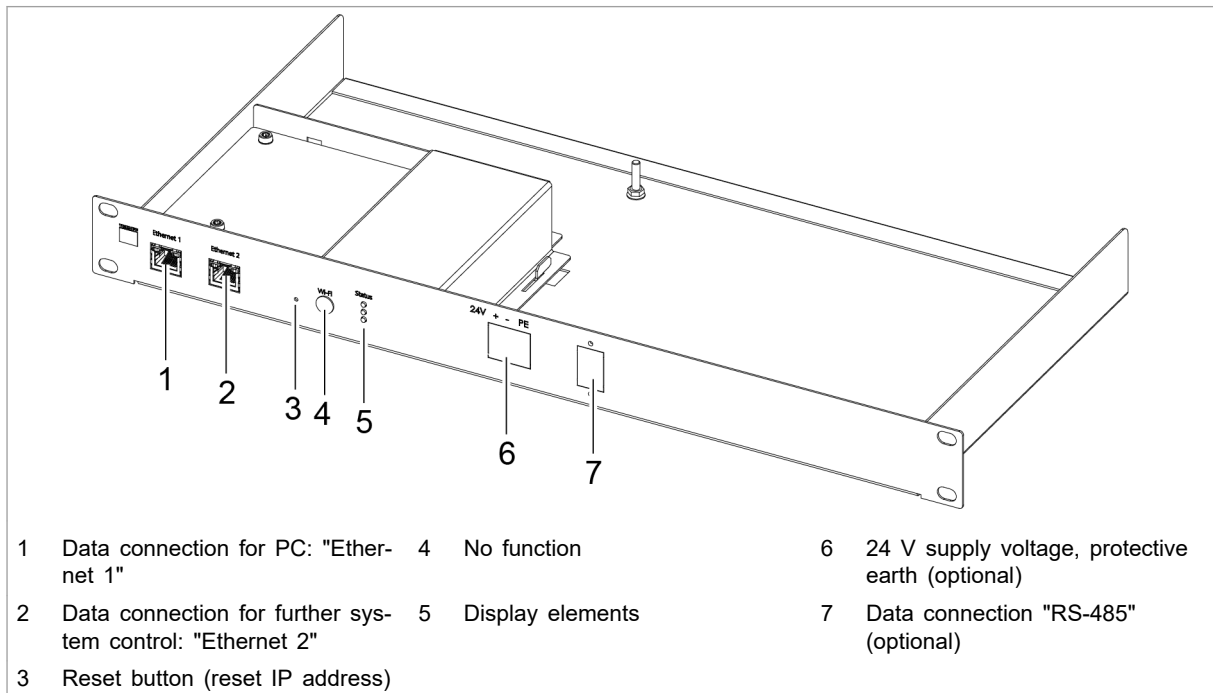

TruConvert System Control front side

Fig. 7

Rear side

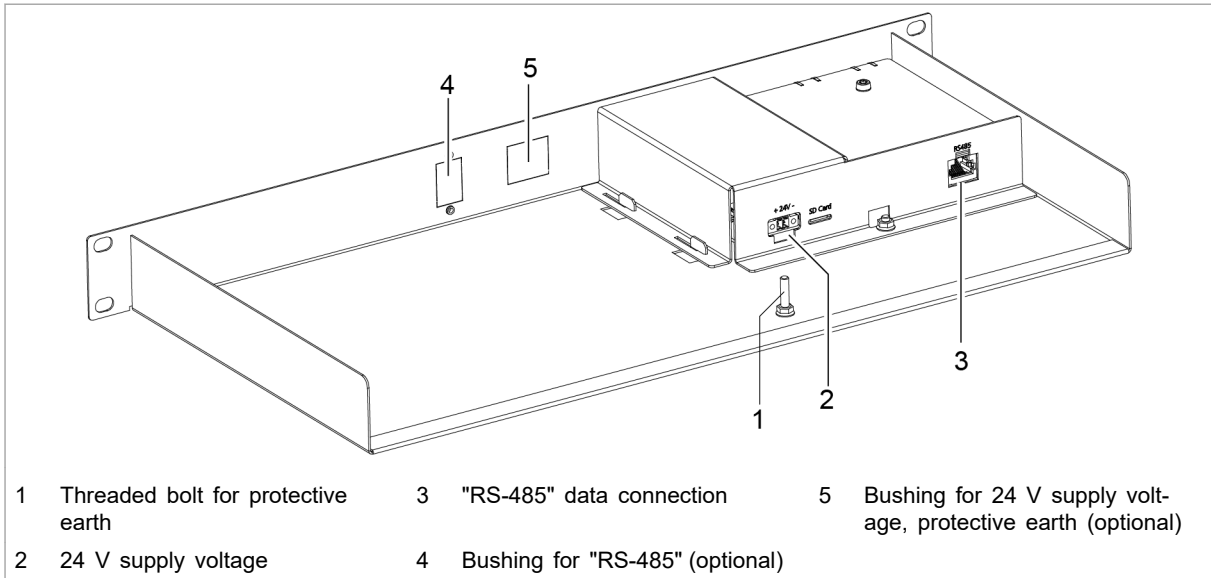

TruConvert System Control rear side

Fig. 8

2.4 Display elements

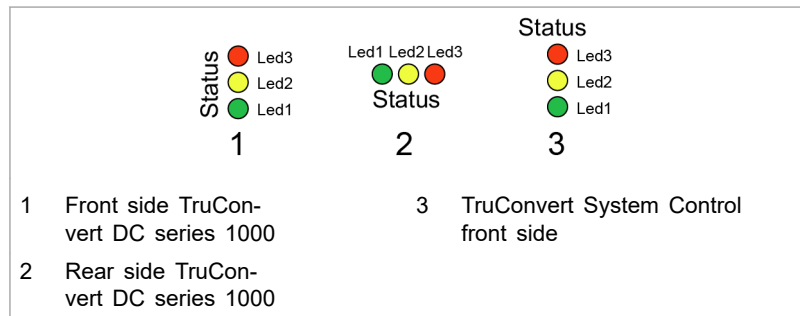

Status LEDs

Fig. 9

LED	Device condition				
	Bootloader	Initialize	Alarm	Idling	Operation
LED1 (green)	on	Flashing	off	Flashing	Flashing
LED2 (yellow)	Flashing	Flashing	off	off	Energy direction <ul style="list-style-type: none"> ▪ Battery charging: LED lights up. ▪ Battery discharging: LED flashes.
LED3 (red)	on	Flashing	Flashing	off	off

Status LEDs

Tab. 4

3. Technical specifications

3.1 TruConvert DC 1030 Data

Entire device	Description	Value
	Max. efficiency At 500 V (LV) and 600 V (HV) (Self-supply not taken into consideration)	99.5 %
	Min. efficiency At 100 V (LV) and 900 V (HV) (Self-supply not taken into consideration)	95 %
	Voltage supply	24 VDC \pm 10 % / 2 A Note Observe for external fuse: switch-on current is briefly three times the nominal current.
	Reaction time (change in energy direction)	< 10 ms
	Protection class	I
	Overvoltage category	III (max. 4 kV impulse withstand voltage)

Entire device

Tab. 5

DC link (high-voltage side)

Description	Value
DC link voltage	<ul style="list-style-type: none"> ▪ 150 VDC to 950 VDC, balanced to earth ▪ Voltage of DC connections to earth: 700 VDC ▪ DC+_HV to PE / PE to DC-: Max. 700 VDC
Rated voltage	850 VDC
Nominal current	36 A
Maximum permissible DC link current	50 ADC max.
Maximum DC link power	30 kW
Input capacitance	80 μ F



DC link (high-voltage side)

Description	Value
Capacitance to earth (DC+/DC- to PE)	35 nF
<p>Fuses:</p> <p>The DC fuses must be provided on-site by the customer.</p> <p>The parameters required for dimensioning the fuses depend on the installation situation in the customer system.</p> <p>The following system parameters form the basis for dimensioning:</p> <ul style="list-style-type: none"> ▪ Internal resistances of the sources present in the DC link ▪ Capacitances present in the DC link ▪ Inductivities present in the DC link <p>Taking into account aging and peak current effects yields the following dimensioning of the rated fuse current:</p> $I_{Fuse} \geq I_{max} \times 1.56 = 50 \text{ A} \times 1.56 = 78 \text{ A}$ <p>The permissible operating voltage of the fuse must be higher than the DC link voltage.</p> <p>Fuse ratings:</p> $U_{Operation} = 1000 \text{ VDC}$ $I_{max} = 50 \text{ ADC}$ <p>Suitable model, e.g.: Contact TRUMPF Service.</p>	

DC link

Tab. 6

Battery connection (low-voltage side)

Description	Value
Voltage range for charging/ discharging	100 V to 700 V DC (With voltage < 100 V with current derating: 10 A at 1 V) (see "Voltage-current characteristic curve (max. current at U < 100 V)", pg. 19)
Rated voltage	428 VDC
Nominal current	70 A
Maximum permissible current	
Nominal power (current- or voltage-dependent)	30 kW
Brief overload while charging/ discharging	–
Reaction time (discharging to charging)	1 to 70 ms (adjustable)
Input capacitance	~110 µF
Capacitance to earth	<ul style="list-style-type: none"> ▪ DC+ to PE: ~2 nF ▪ DC- to PE: ~35 nF

Battery connection

Tab. 7

Measuring accuracies

Description	Value
Battery voltage	± 1 V (corresponds to $\pm 1\%$ at 100 V)
Battery current	± 1 A (corresponds to $\pm 1.5\%$ at 70 A) Applies for the entire range.
DC link voltage	± 10 V (corresponds to $\pm 1\%$ at 1000 V) Applies for the entire range.

Measuring accuracies

Tab. 8

Voltage-current characteristic curve (max. current at U < 100 V)

At a battery voltage < 100 V, the battery current is reduced (charging and discharging).

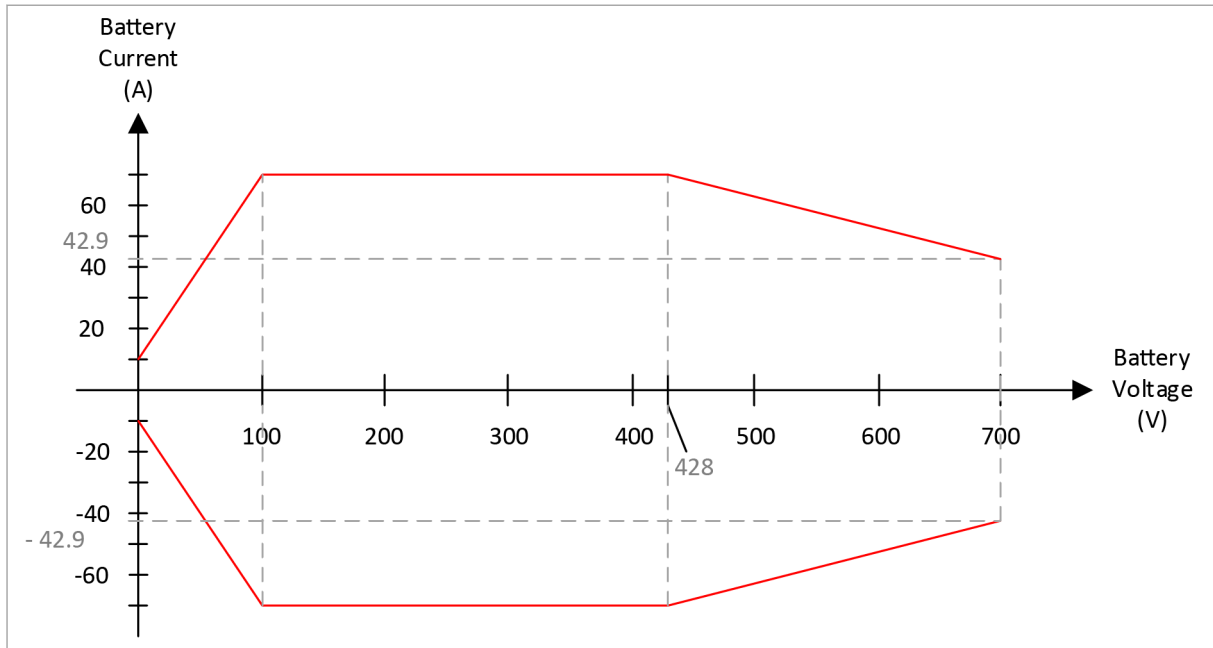

Voltage-current characteristic curve

Fig. 10

Life span

Description	Value
Typical life span	> 10 years

Life span

Tab. 9

Interfaces

Description	Connection
Battery connection	PCB plug connector, 5-pin IPC 16/ 5-GF-10.16 - 1702769 from Phoenix Contact
DC link (DC Link)	PCB plug connector, 5-pin IPC 16/ 5-GF-10.16 - 1702769 from Phoenix Contact
24 V supply voltage, DC (24 V)	PCB plug connector, 2-pin GMSTB 2.5 HCV/2-ST-7.62- LR-1812759 from Phoenix Contact
Data input for RS-485 (IN)	RJ-45
Data output for RS-485 (OUT)	RJ-45
Protective earth	M6 threaded bolt on rear side of housing

Interfaces

Tab. 10



Housing

Description	Value
Dimensions W x H x D (incl. connection components)	½ 19" x 2 HU x 471.1 mm
	½ 19" x 2 RU x 18.55"
Dimensions W x H x D (without connection components)	½ 19" x 2 HU x 451.1 mm
	½ 19" x 2 RU x 17.76"
Weight	7 kg
Housing material	Galvanized sheet steel
Protection class	IP 20
Abbreviation: HU = Height unit = 44.45 mm	

Housing

Tab. 11

Dimensional drawing Dimensional drawing with dimensions for installation:

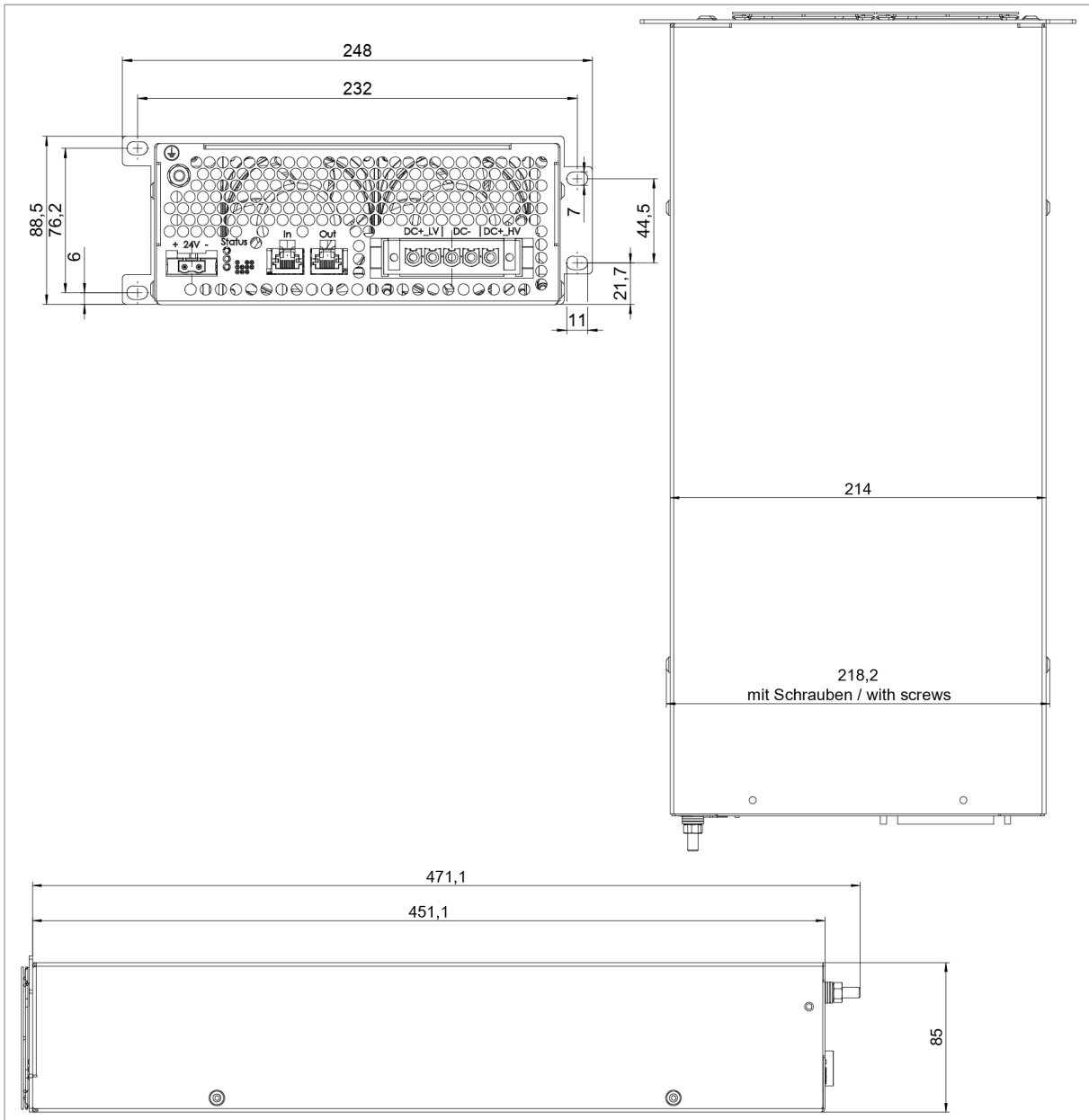

Dimensional drawing

Fig. 11

Sound emissions

Description	Value
Sound emission level Distance of 1 m from DC-DC module	< 70 dB(A)

Sound emissions

Tab. 12

Environmental conditions

Condition	Temperature	Humidity ¹	Air pressure	Contamination Micro-environment complies with IEC 62109-1
Rated operation	-5 °C to +50 °C +23 °F to +122 °F	5 ... 90%	Up to approx. 78 kPa (± 2000 m high above sea level)	Pollution degree 2
Limited power operation	+50 °C to +65 °C +122 °F to +149 °F			
Storage	-20 °C to +80 °C -4 °F to +176 °F	5 ... 90%		
Transport	-20 °C to +80 °C -4 °F to +176 °F	< 90 %		

Environmental conditions

Tab. 13

3.2 TruConvert System Control data

Interfaces	Description	Value
	24 V supply voltage, DC	24 V DC ± 10 % / 250 mA PCB plug connector, 2-pin
	Ethernet interface 1	<ul style="list-style-type: none"> ▪ Connection for web-based user interface or Modbus TCP/UDP ▪ RJ-45
	RS-485 interface	<ul style="list-style-type: none"> ▪ Connection for TruConvert AC 3025 or TruConvert DC series 1000 ▪ RJ-45
	Reset button	Resetting the IP address
	Display	3 status LEDs

TruConvert System Control interfaces

Tab. 14

Housing	Description	Value
	Dimensions W x H x D	Approx. 435 mm x 44.5 mm x 253 mm Approx. 17.13" x 1.75" x 10"
	Dimensions of front panel	Approx. 482 mm x 44.5 mm Approx. 19" x 1.75"

Housing

Tab. 15

¹ No condensation or icing

Dimensional drawing

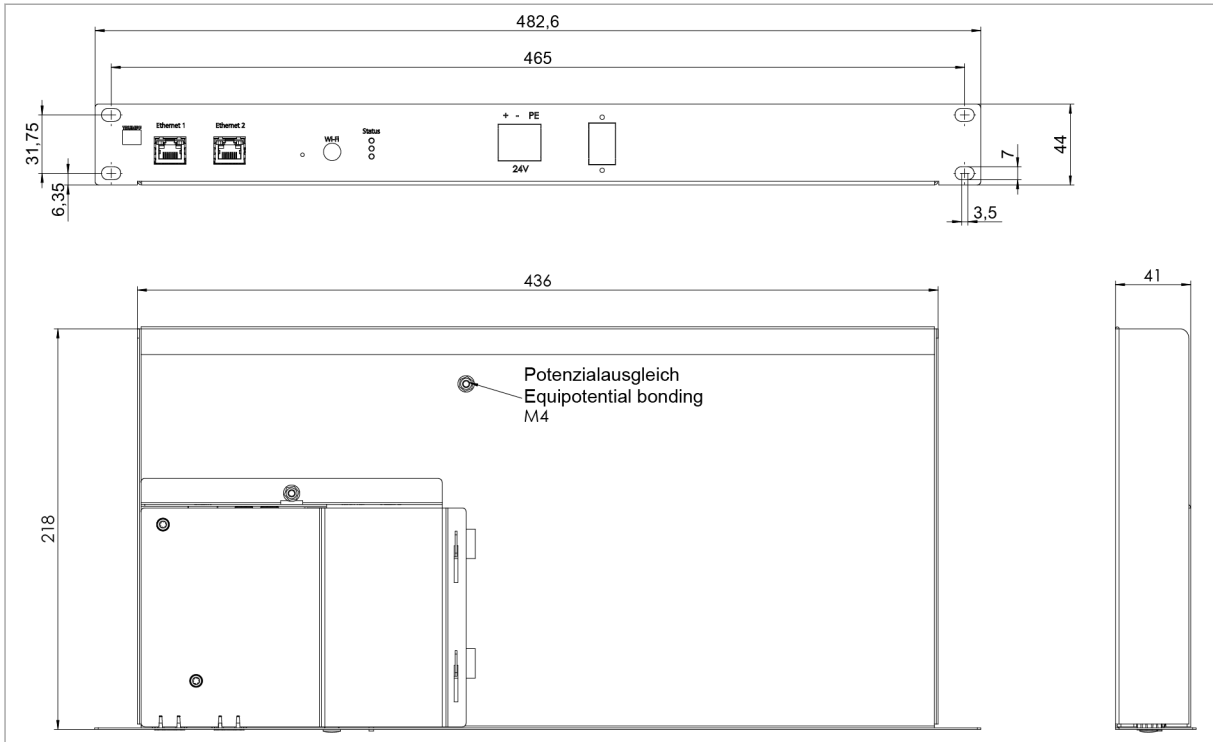

Dimensional drawing

Fig. 12

Environmental conditions

Condition	Temperature	Humidity ²	Air pressure	Contamination Micro-environment complies with IEC 62109-1
Operation	-5 °C to +65 °C 23 °F to +149 °C	5 ... 90 %	Up to approx. 78 kPa (Δ 2000 m high above sea level)	Pollution degree 2
Storage	-20 °C to +80 °C -4 °F to +176 °F	5 ... 90 %		
Transport	-20 °C to +80 °C -4 °F to +176 °F	< 90 %		

Environmental conditions

Tab. 16

² No condensation or icing

4. Interfaces

4.1 Protective earth

View

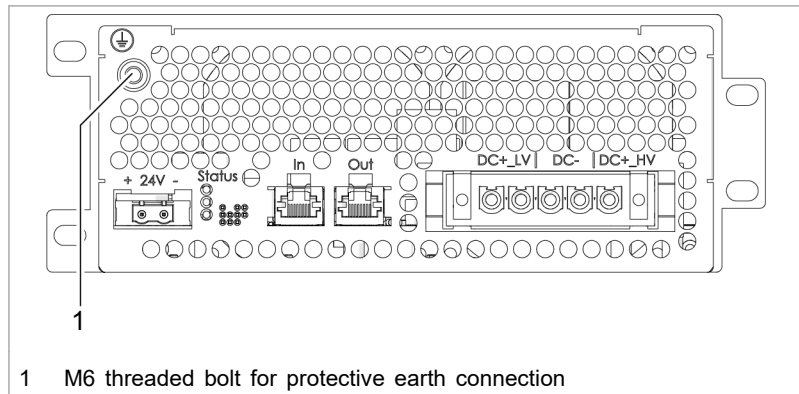

Protective earth connections

Fig. 13

- Connection**
- On the rear side of the housing: M6 threaded bolt, torque: **5 Nm**.

Cable requirement The cross section of the protective earth is dependent on the **grounding concept** of the overall system.

- Grounding concept 1: battery cables ungrounded**
- 1 x 10 mm² / 1 x AWG 7

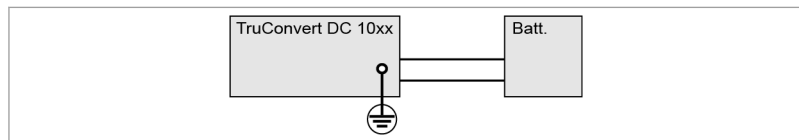

Fig. 14

- Grounding concept 2: battery cables grounded at middle**
- The cross section of the protective earth must be calculated by the system manufacturer according to the battery properties and fuse properties.

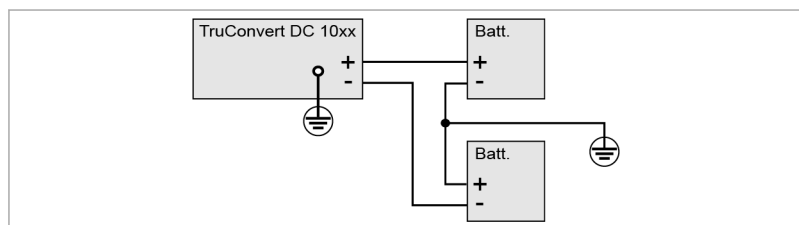

Fig. 15

4.2 Supply voltage 24 V DC

Note

The negative terminal of the supply voltage is **not** connected to PE in the DC-DC module.

Grounding of the "-24V" connection must be provided by the customer as close as possible to the device.

Grounding of the "-24V" connection must be provided by the customer as close as possible to the device.

View

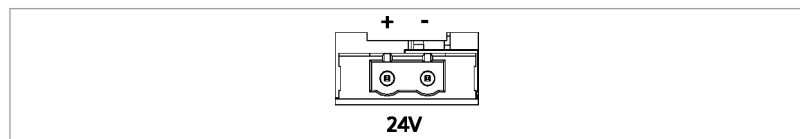

24 V supply voltage (DC)

Fig. 16

- Connection**
- At the DC-DC module: Phoenix PCB plug connector
 - Required counterpart: 2-pin connector, 16A, GMSTB 2.5 HCV/ 2-ST-7.62-LR

- Cable requirement**
- Max. 1.5 mm² / max. AWG 16

Fuse External fuse protection must be provided by the customer.

4.3 DC link connection and battery connection

View

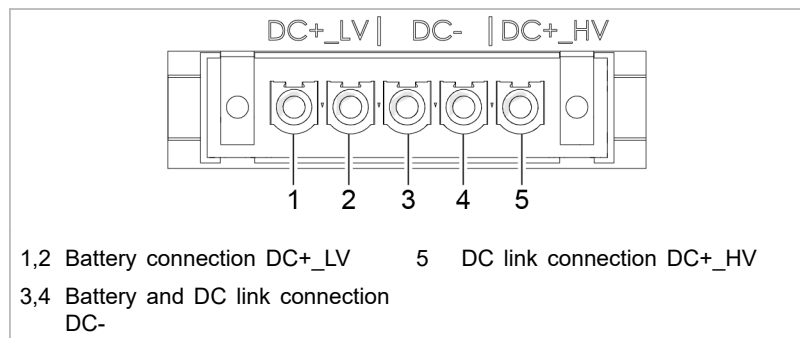

Battery connection

Fig. 17

- Connection**
- At the DC-DC module: Phoenix PCB plug connector
 - Required counterpart: connector, 5-pin, 76 A, 1000 V, IPC 16/5-STF-10,16

Cable requirement Select min. cross section according to local regulations.

Recommendation:

- Position 1 to 4: 6 mm² or AWG 9
- Position 5:
 - 2 x 6 mm² or 2 x AWG 9
 - or: 10 mm² or AWG 7
- Choose an insulation with sufficient electric strength.

Note

To keep inductivity at a minimum cables should be twisted.

Internal fuse protection 125 A on DC+_LV.

Separators The customer must install suitable separation devices into the connection between the DC-DC module and battery.
The separation devices must comply with applicable standards.

- Connection types**
- Individual connection.
 - Parallel connection (up to 16 DC-DC modules).

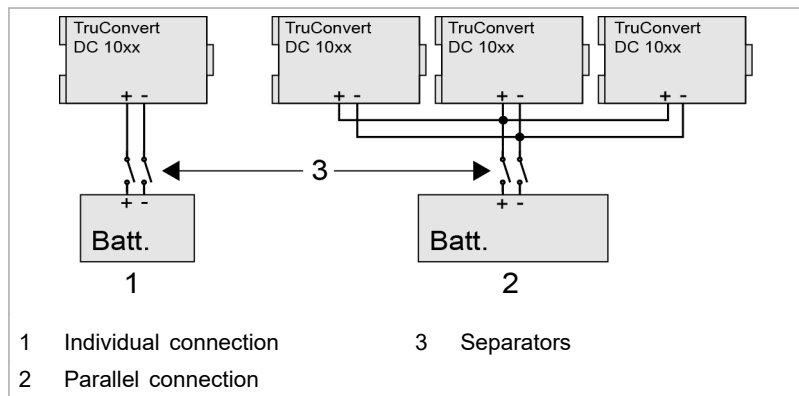

Connection types for the batteries

Fig. 18

4.4 RS-485 data input/data output (IN/OUT)

View

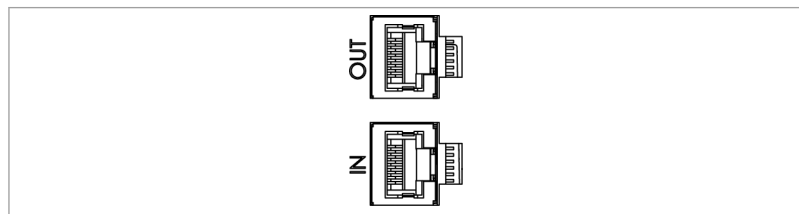

Data connections IN/OUT

Fig. 19

Connection ■ RJ-45 male connector

Cable requirement ■ Twisted pair patch cable in accordance with standard TIA/EIA-568A/B
 ■ CAT 5 or higher
 ■ Max. length: 30 m

Note

The total length of the data cable must not exceed 30 m from the PC to the last system control.

4.5 Interfaces on the system control

TruConvert System Control These interfaces are located on the system control TruConvert System Control.

24 V supply voltage (DC)

Note

The negative terminal of the supply voltage is **not** connected to PE in the TruConvert System Control. Grounding must be performed by the customer, as close to the housing as possible.

View

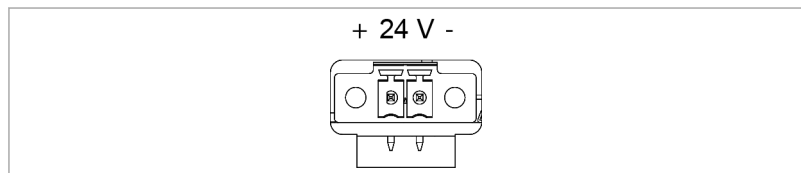

24 V supply voltage (DC)

Fig. 20

Connection

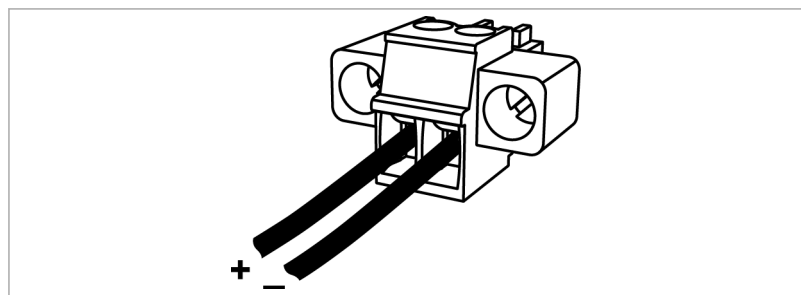

Connector for 24 V supply voltage (DC)

Fig. 21

- On the device: Phoenix PCB plug connector
- Required counterpart: connector, 2-pin, 8A, CS 3.5 mm

Fuse External fuse protection must be provided by the customer.

Ethernet

View

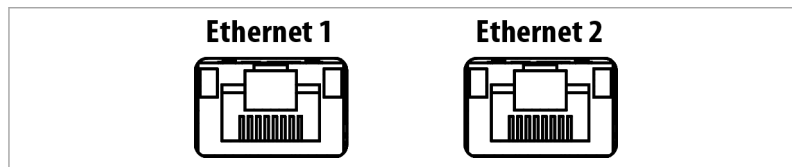

Ethernet data connection

Fig. 22

Connection ■ RJ-45 male connector

- Cable requirement**
- Twisted pair patch cable in accordance with standard TIA/EIA-568A/B
 - CAT 5 or higher
 - Max. length: 100 m

RS-485

View

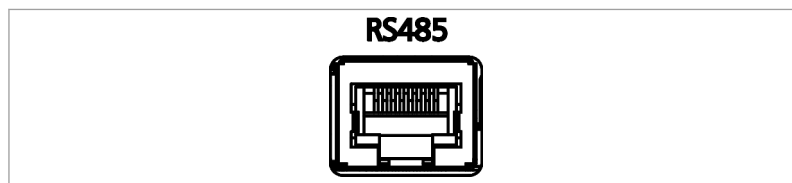

RS-485 data connection

Fig. 23

Connection ■ RJ-45 male connector

- Cable requirement**
- Twisted pair patch cable in accordance with standard TIA/EIA-568A/B
 - CAT 5 or higher
 - Max. length: 30 m

Note

The total length of the data cable must not exceed 30 m from the PC to the last system control.

5. Standards and directives

5.1 CE certification

EU directives:

- Low-voltage directive 2014/35/EU
- Electromagnetic compatibility directive 2014/30/EU

Standards taken into account:

- EN 62040-2: 2006/AC: 2006
- EN 62109-1:2010
- UL 1741
- IEC 62109-2
- IEC 62477-1

5.2 EU declaration of conformity TruConvert DC 1030

TRUMPF



EU Declaration of Conformity

in accordance with
Low Voltage Directive 2014/35/EU
Directive relating to electromagnetic compatibility 2014/30/EU

We hereby declare that the following device complies with all the relevant requirements of the EU directives listed above.

Device:	TruConvert DC 1030
Serial number:	≥ 206046980
Applied harmonized standards, in particular:	EN 62109-1:2010, EN 62040-2:2006/AC Klasse C2
Party authorized to compile the technical file:	Benedikt Röser

Town / Date / Signature Freiburg im Breisgau, 06.08.2021

Benedikt Röser
Quality Director

TRUMPF Hüttinger GmbH + Co. KG
Bötzinger Straße 80
79111 Freiburg im Breisgau, Germany

Phone +49 (0) 761 8971-0
Fax +49 (0) 761 8971-1150

Info.Elektronik@de.trumpf.com
www.trumpf.com

TE551sc
V 2021 - 07

en

EU declaration of conformity TruConvert DC 1030

Fig. 24

5.3 EU declaration of conformity TruConvert System Control

Class C1 is achieved when the supply lines of the 24 V supply voltage are equipped with the provided ferrite cores. Otherwise class C2 is achieved.

TRUMPF



EU Declaration of Conformity

in accordance with
Low Voltage Directive 2014/35/EU
Directive relating to electromagnetic compatibility 2014/30/EU

We hereby declare that the following device complies with all the relevant requirements of the EU directives listed above.

Device:	TruConvert System Control
Serial number:	≥ 203622306
Applied harmonized standards, in particular:	EN 62109-1:2010, EN 62040-2:2006 / AC Klasse C1
Party authorized to compile the technical file:	Benedikt Röser

Town / Date / Signature Freiburg im Breisgau, 10.02.2020

Benedikt Röser
Quality Director

TRUMPF Hüttinger GmbH + Co. KG
Bötzingen Straße 80
79111 Freiburg im Breisgau, Germany

Phone +49 (0) 761 8971-0
Fax +49 (0) 761 8971-1150

Info.Elektronik@de.trumpf.com
www.trumpf.com

TE172sc
V 2019 - 11

en

6. Installation

6.1 Inspecting the delivery

1. Check the device immediately as soon as it is delivered for completeness in accordance with the delivery note and also for visible damages incurred during transport.
2. In order to retain the right of recourse, report any shipping damages immediately in writing to the forwarding agent, the insurance company and TRUMPF.

6.2 Disposing of packaging material

If you do not want to keep the packaging material for a subsequent transport:

- Dispose of all packaging materials in compliance with the relevant regional waste disposal regulations.

6.3 Transport

1. Transport DC-DC-module in the original packaging.
If the original packaging is no longer available:
Suitable packaging material can be purchased from TRUMPF.
2. Maintain specified environmental conditions.

6.4 Storage conditions

If you do not install the module immediately following delivery:

1. Store the module in original packaging.
If the original packaging is no longer available:
Suitable packaging can be purchased from TRUMPF.
2. Maintain specified environmental conditions.

6.5 Requirements for the site

- Installation indoors**
- Operation is permissible in a closed electrical operating room only.
 - According to **IEC 62477-1**, installation, mounting and operation are only permissible in:
 - Non-flammable environment.
 - Indoors with air conditioning.

Air intake and air outlet Sufficient space must be present for air intake and air outlet.

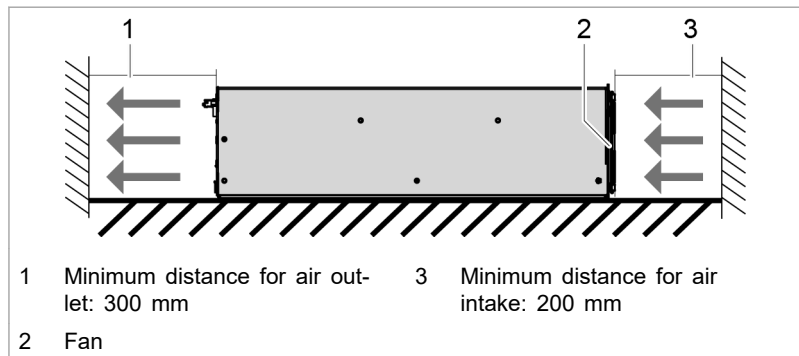

Air circulation intervals

Fig. 26

Maximum back pressure Sufficient cooling of the module is only ensured if a sufficient air flow rate up to a maximum permissible back pressure is provided.

In addition, note that the air flow rate must be multiplied by the number of devices if several modules are operated.

Air short circuits and mutual interference of the modules must be prevented.

Number of modules	Air flow rate	Maximum back pressure in the air duct
1	300 m ³ /h	15 Pa
n	n x 300 m ³ /h	15 Pa

Maximum back pressure

Tab. 17

Mains separation device Access to the external mains separation device must not be obstructed by the device.

Fuses Fuses must be provided on-site by the customer .

Dependent safety requirements The TruConvert AC 3025 device is a transformerless inverter:

- Without internal voltage isolation.
- Without integrated, automatic separation device.
- Without integrated residual-current protection monitoring.

The implementation of, compliance with and monitoring of the dependent safety requirements lies solely and completely with the responsible system operator or a third party commissioned by the system operator .

6.6 Possible installation positions

Horizontal position

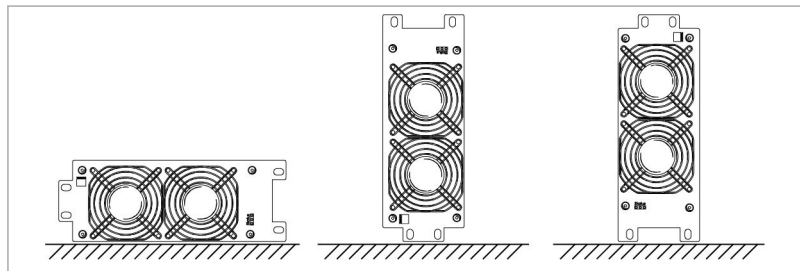

Possible orientations in horizontal position

Fig. 27

Operation in a horizontal position is permitted without restrictions.

Vertical position

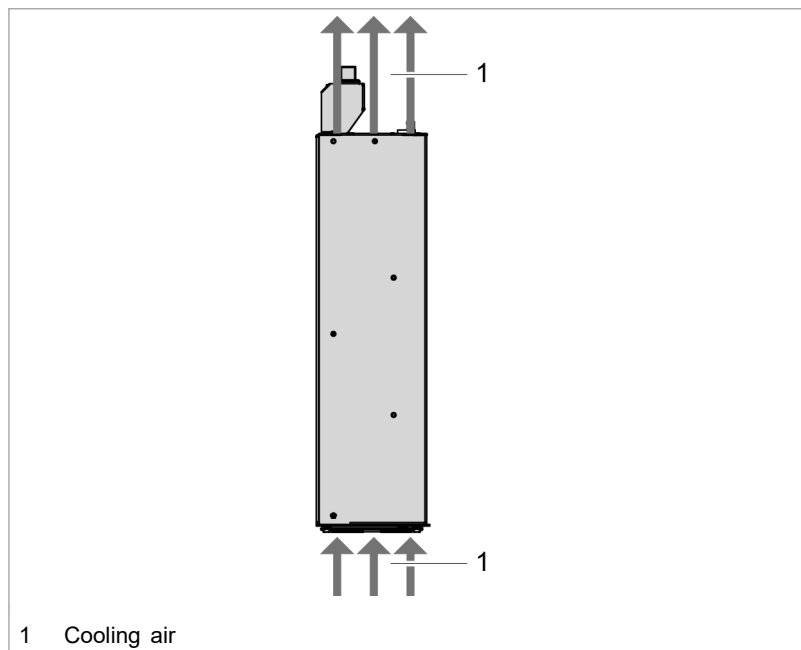

1 Cooling air

Possible orientation in vertical position

Fig. 28

Operation in a vertical position is only permitted under the following conditions:

- The cooling air moves in the upwards direction.
- Installation of a collection tray under the DC-DC module.
The collection tray must prevent any glowing parts from the device from dripping onto a flammable base. The collection tray therefore fulfils the function of a fire protection housing.

6.7 Electrical connection

Note

All installation work must comply with the specifications of the Authority Having Jurisdiction (AHJ).

DANGER

Connection cables carry life-threatening voltage.

- Do not work under voltage.
- Before connecting, check battery cables to ensure that they are not electrically live.
- Before connecting, check DC link voltage cables to ensure that they are not electrically live.

DANGER

Danger of fire

- Observe the installation regulations of the installation site.
- Fuse the battery connection and DC link at all poles.
- Dimension the fuse protection according to the application and intended use of the device. (Battery connection is protected internally with 120 A / 700 VDC_{max})

NOTICE

Destruction of the device by reverse polarity at the battery connection.

- Observe the pole designation (+ and -).
- After polarity reversal: Do **not** switch on the device again.
Danger of fire!

NOTICE

Abrupt connection of the DC link voltage can destroy DC-DC modules.

- Slowly increase the DC link voltage of 0 V to maximum voltage (ramp > 1 s).

NOTICE

Abrupt connection of the battery voltage can destroy the DC-DC module.

- Pre-charge battery connection parts of the DC-DC module to current battery voltage.

Establishing electrical connection

Condition

- Battery is fully discharged for all connection work.

or

- If it is not possible to fully discharge the battery, appropriate separators are to be installed in the connection between DC-DC module and battery.
- The separation devices must comply with applicable standards.
- Before closing the separators, the battery connections must be pre-charged to the current battery voltage!

Means, Tools, Materials

- Terminating resistor for the data output (provided).
- If necessary, pre-charger for pre-charging the battery connections on the DC-DC module to battery voltage.

Note

At each TruConvert System Control, only DC-DC modules of the same power class may be connected.

Control of a mixed group consisting of TruConvert DC 1008 and TruConvert DC 1010 is not possible.

Connecting protective earth to DC-DC module

1. Screw protective earth to the threaded bolt of the housing back panel. Max. torque: 8 Nm.

Connecting protective earth to system control

2. Screw protective earth on TruConvert System Control. Max. torque: 2 Nm.

Connecting the battery

3. Fully discharge the battery and ensure absence of voltage.
 - or**
 - If the battery cannot be discharged: open separators on the battery.
4. Use end sleeves for the connection cables (battery, DC link).

NOTICE**Destruction of the device by reverse polarity at the battery connection.**

- Observe the pole designation (+ and -).
- After polarity reversal: Do **not** switch on the device again. Danger of fire!

Connect the loaded battery

5. Connect the battery cables. Observe polarity.
6. Ensure that the separator is open.
7. Pre-charge battery connections to current battery voltage with suitable pre-charger.
8. Close separator.

Connecting DC link**⚠ DANGER****Connection cables carry life-threatening voltage.**

- Do not work under voltage.
- Before connecting, check DC link voltage cables to ensure that they are not electrically live.

9. Connect the DC link voltage cables.

or

- During parallel operation of several DC-DC modules: Connect "DC Link" interfaces of the DC-DC modules in parallel and connect DC link voltage cables.

Check connections: DC link and battery

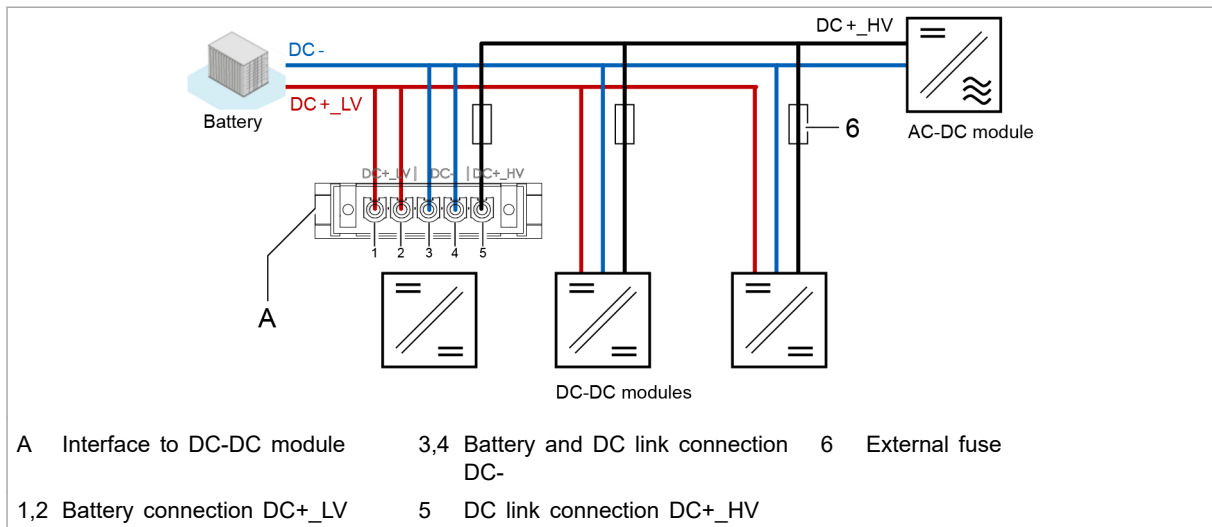

DC link connection and battery connection Fig. 29

10.

Recheck correct connection positions for DC+_LV, DC-, DC+_HV.

Connecting data cable

11. Connect data connection "RS-485" of the TruConvert System Control with data input "IN" of the DC-DC module.
12. Connect the terminating resistor to the "OUT" data output of the DC-DC module.

or

- If several DC-DC modules are connected in parallel: Connect the "OUT" data output of the DC-DC module to the "IN" data input of the next DC-DC module.

Connect the terminating resistor to the "OUT" data output of the last DC-DC module.

13. Connect the TruConvert System Control to the master (Modbus master or PC with web browser)

Connect 24 V supply voltage

14. Connect supply voltage 24 VDC to the DC-DC module.
15. Connect the 24 VDC supply voltage to the TruConvert System Control.

LED1 (green) flashes and shows that the DC-DC module is operational (see "Display elements", pg. 15).

Using ferrite core to achieve the limit value for level C1

Means, Tools, Materials

- A: 1 ferrite core for DC link and battery supply line, e.g., Würth 74271251S, can be ordered through TRUMPF (material no. 2661105)
- B: 1 ferrite core for the TruConvert System Control (supplied)

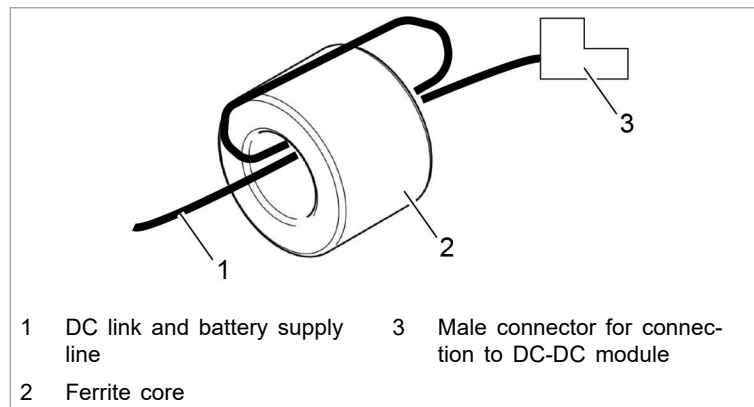

Ferrite core

Fig. 30

1. Install a ferrite core A on the cables for the DC link connection and battery connection of the DC-DC module:
 - Wrap the cables together once around the ferrite core so that the cable passes twice through the hole of the ferrite core.
 - Position the ferrite core as closely as possible to the male connector.
2. Install a ferrite core B on the cable for the 24 V supply of the system control:
 - Wrap the cable once around the ferrite core so that the cable passes twice through the hole of the ferrite core.
 - Position the ferrite core as closely as possible to the male connector.

Connection diagram with 3 DC-DC modules (example)

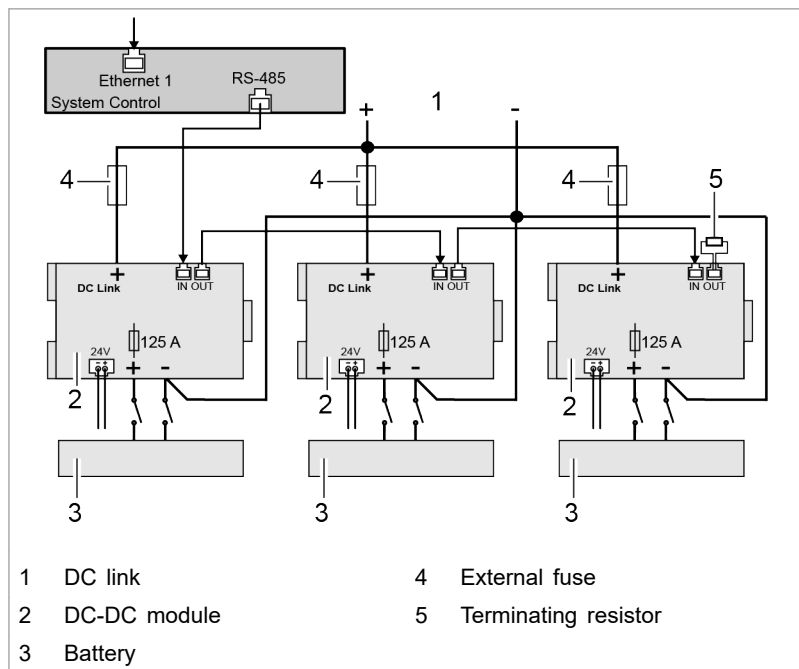

Connection diagram: example with 3 DC-DC modules

Fig. 31

Note

The terminating resistor **must** be connected to the last bus participant to ensure data transmission.

The terminating resistor must be connected even if there is only one bus participant.

Use only the **provided terminating resistor**.

6.8 Dismantling the DC-DC module



Connection cables carry life threatening voltage!

- Fully discharge battery.
- If the battery cannot be discharged: open separators on the battery.
- De-energize the connection cables to the DC link voltage.
- Maintain discharging time.

Removing residual voltages

1. Fully discharge battery.

- or**
- If the battery cannot be discharged: open separators on the battery.
2. De-energize the connection cables to the DC link voltage.
 3. De-energize the connection cables to the 24 V supply voltage.

Unscrew or unplug cables

4. Unplug connection cables to the battery for the DC link voltage on the DC-DC module.
5. Unplug supply voltage 24 V DC.
6. Unplug data cable.
7. Unscrew protective earth.

6.9 Shipping the module

- Use packaging material which can withstand transport stresses to ship the module.

If the original packaging is no longer available:
Suitable packaging material can be purchased from TRUMPF.

6.10 Disposing of the module

- Observe the local regulations when disposing of the module.

7. Operation

7.1 Commissioning

Performing initial commissioning

Conditions

- PC on which one of the following browsers is installed:
 - Microsoft Internet Explorer from version 11.
 - Microsoft Edge.
 - Google Chrome from version 46.
 - Firefox from version 40.
- Ethernet cable for connecting PC and TruConvert System Control.

The initial commissioning of the device is **only** possible via the web GUI.

Establishing and testing the connection

1. Set the same IP Subnet Mask on the PC as on the TruConvert System Control.
IP Subnet Mask of the TruConvert System Control on delivery: 255.255.255.0
2. Set the same address range on the PC as on the TruConvert System Control:
192.168.1.-
3. On the PC, set the last block of the IP address.
Do not set the same address as on the TruConvert System Control!
IP address of the TruConvert System Control on delivery: 192.168.1.2
Do not set 0!
4. Connect PC and TruConvert System Control with Ethernet cable.
5. To switch on the system control and the modules: switch on the 24 V supply voltage.
All 3 status LEDs blink to display the "Initialization" state.
6. Open the web browser on the PC.
7. Enter IP address of the TruConvert System Control in the address line.
IP address of the TruConvert System Control on delivery: 192.168.1.2

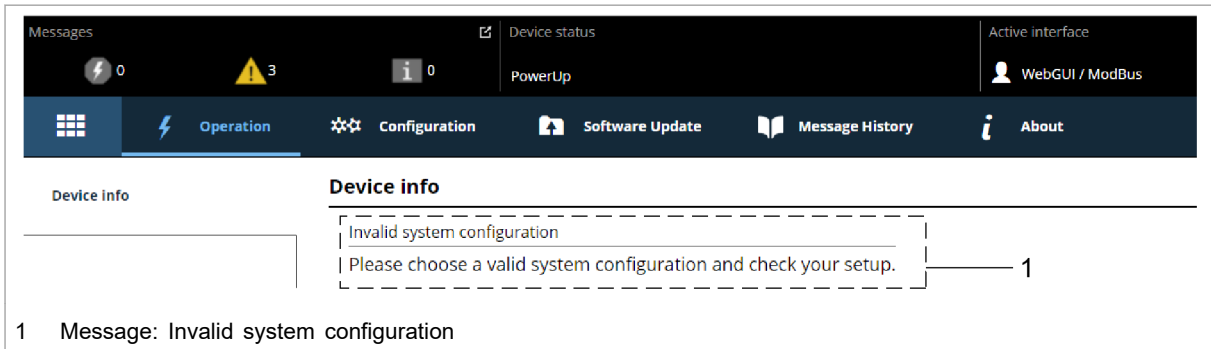

Initial commissioning display

Fig. 32

The browser displays the web GUI.

Several system controls are used in one system?

- Connect one system control after another to the PC and change the default IP address to a unique IP address.

Setting the system configuration

8. Select >Configuration >System configuration.

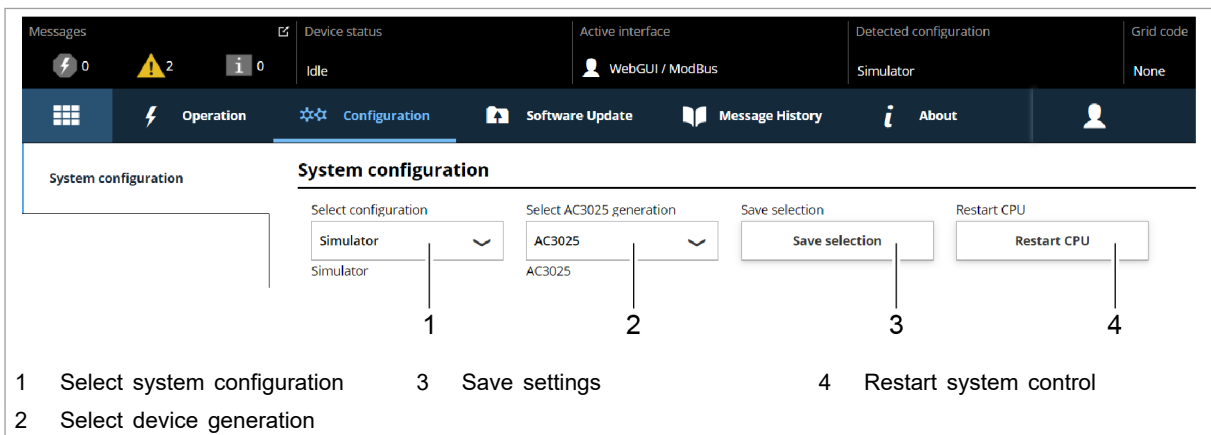

Screen: Set system configuration

Fig. 33

9. In "Select configuration", select the present system configuration:
 - No configuration
This configuration only occurs in the event of an error, e.g., if there is no connection to the modules (check cables) or if an incorrect module type was detected (check alarm messages).
 - Simulator
The system control alone is used and connected modules are simulated.

- "Maximum charge voltage": upper limit, up to which the battery is charged.
Upon reaching the limit value, the charging current is reduced.
 - "Alarm threshold voltage": upper limit, up to which the battery is charged.
If the value is exceeded, the TruConvert System Control generates an alarm message and switches off.
 - Select the alarm limit values so that they are outside of the "Minimum discharge voltage" and "Maximum charge voltage" control range.
The difference between "Minimum discharge voltage" and "Alarm threshold voltage" should be 5 V. A smaller difference is possible as well but may result in shut-downs.
 - "Maximum charge current": limit value for the charging current.
 - "Maximum discharge current": limit value for the discharging current.
 - "Maximum power": limit value for the power output/power draw.
17. In the "Voltage current characteristic (VCC) settings" area, enter the values for the voltage-current characteristic curve :
- "VCC start point current": battery current at minimum battery voltage.
 - "VCC end point current": battery current upon reaching "VCC end point voltage".
 - "VCC end point voltage": battery voltage.

The charging and discharging current of a battery are set as a function of the voltage with the "VCC settings". The values

must be selected so that they lie in the voltage-current characteristic curve.

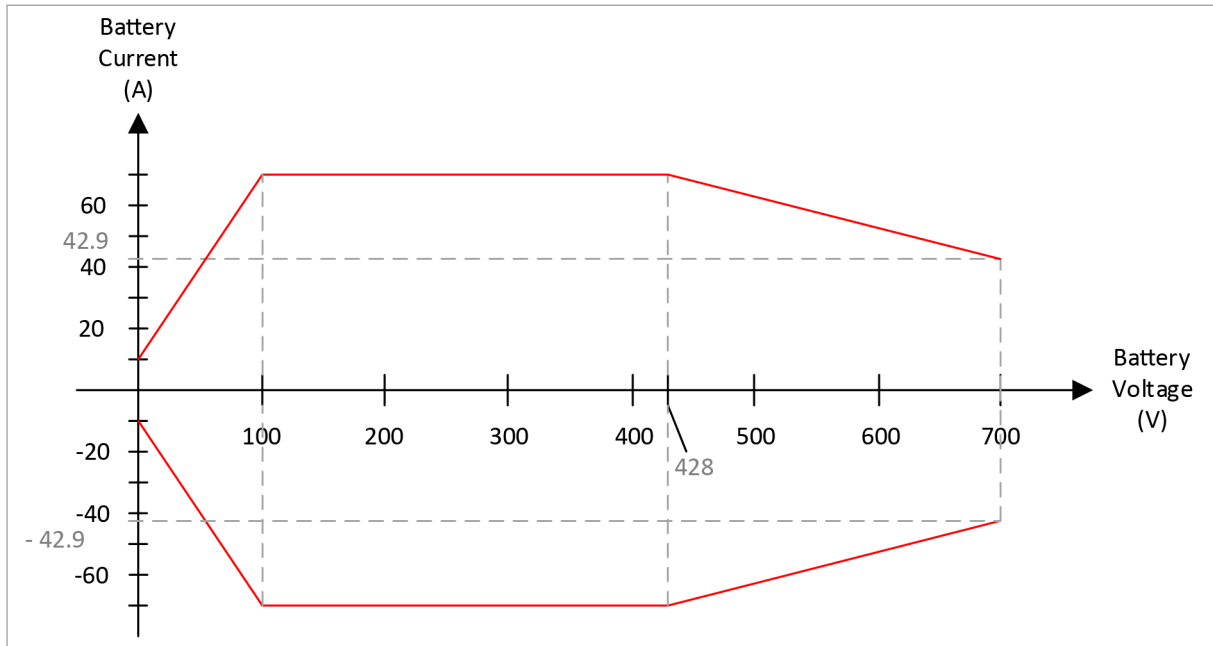

Voltage-current characteristic curve

Fig. 35

Start transmission of power

18. Check the device status in the status bar at the top of the user interface:

- "Device status: Idle": Idle: The device is ready for use.
- "Device status: Error, Power Up": Error: The device is not ready for use. An alarm message is pending (see "Displaying and resetting messages", pg. 61).

or

- Check status LED 1 on the DC-DC module:
 - LED flashes green: The device is ready for use.
 - LED flashes red: The device is not ready for use. An alarm message is pending (see "Displaying and resetting messages", pg. 61).

19. Select >Operation >Device control DC-DC mode.

20. Set the following in the "Device control DC-DC" area:

- "Set value battery current": battery current set value in A.
Charge battery: enter negative value (-250 to 0).
Discharge battery: enter positive value (0 to +250).
- "Battery current slope": maximum allowed battery current change in A/ms (default value = 100 A/ms).

21. To start the transmission of power: press "Activate power stage".

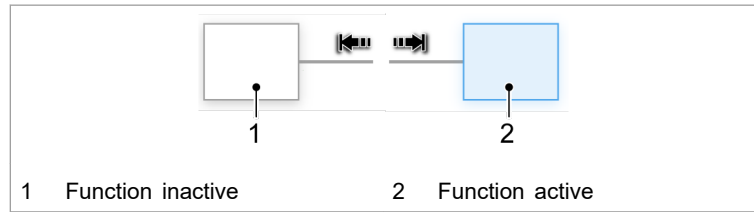

Slide control

Fig. 36

The slide control changes position and is displayed in blue: The function is active.

In the status bar, the operating state changes from "Idle" to "Operation".

The status LEDs on the AC-DC module and system control light up orange. The contactor connects the mains.

Stop transmission of power

- 22. To stop the transmission of power: press "Activate power stage" again.

The slide control changes position and is displayed in white: The function is disabled.

In the status bar, the operating state changes from "Operation" to "Idle".

The status LEDs on the AC-DC module and system control light up green. The contactor disconnects the mains.

The initial commissioning is completed.

The device can now continue to be operated via the web GUI or via Modbus.

Tip

The Modbus register provides an overview of the set default values (see "Modbus Register Map", pg. 54).

7.2 Active interface

The device can be **simultaneously** controlled via the web GUI and Modbus.

Enabling/disabling interface

- Web GUI: In the "Interface control" area of the 👤 expandable menu, click on the slide control.
- Other interfaces: get/release control via interface command, (see "Modbus Register Map", pg. 54).

Communication timeout

During power operation ("Device status" = "operation"), communication between the active interface and the device is monitored. As soon as no communication occurs for a period exceeding the time-out time, the device switches off with an alarm message.

Setting the time-out time:

- Select *>Configuration >System configuration*.
- In the "General system settings" area, enter the desired time under "Active interface communication timeout".
- To switch off the time-out mechanism: enter 65535.

7.3 Operation via web-based user interface

Calling up the web GUI

Condition

- Initial commissioning was performed (see "[Commissioning](#)", pg. 42).
1. To switch on the TruConvert System Control and the connected modules: switch on the 24 V supply voltage.
 2. Open the web browser on the PC.
 3. Enter IP address of the TruConvert System Control in the address line.

IP address of the TruConvert System Control on delivery:
192.168.1.2

The browser displays the user interface of the TruConvert System Control and the connected modules.

Orientation of the user interface

After entering the IP address in a web browser, the web GUI opens.

Start screen

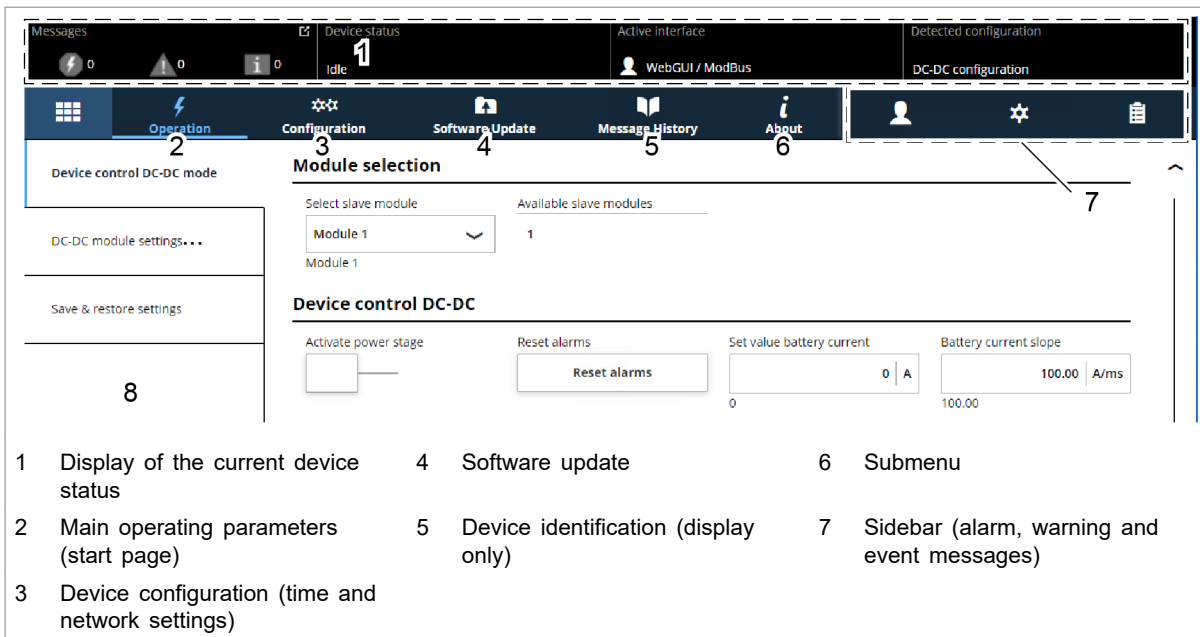

Start screen

Fig. 37

User interface

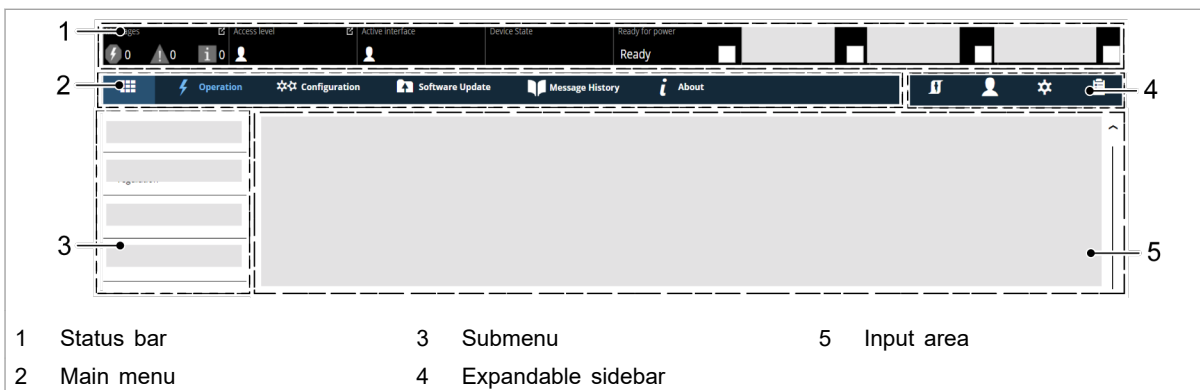

Arrangement of the user interface

Fig. 38

Status bar signaling

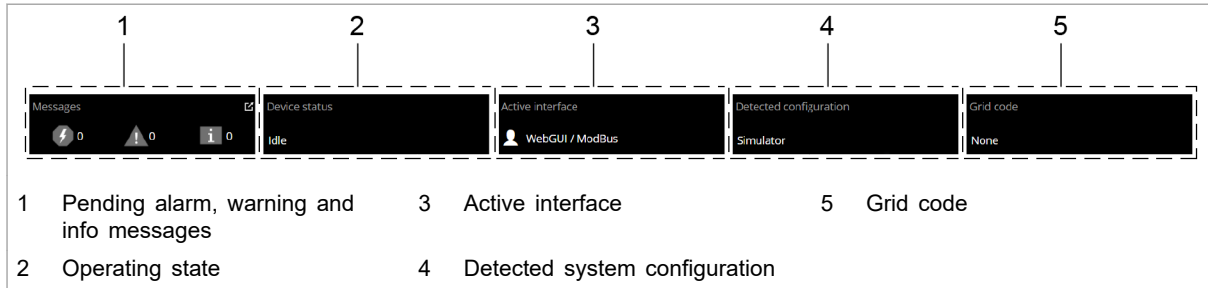



Status bar: information



Fig. 39

Expandable sidebar

The sidebar is divided into three menu items that are labeled with an icon.

- User settings 
- Network settings 
- Pending messages 

Simply click on the icon to open / close the submenu.

		
"Change user role" <ul style="list-style-type: none"> ▪ Display active user role. ▪ Change user role. 	Set system clock and date.	"Pending messages" <ul style="list-style-type: none"> ▪ "Alarm" ▪ "Warning" ▪ "Info" <p>Note</p> <p>The display can be activated / deactivated for each message type.</p>
"Interface control" <ul style="list-style-type: none"> ▪ Activate the web GUI. ▪ Deactivate the web GUI. 	Network settings <ul style="list-style-type: none"> ▪ enter ▪ edit 	"Reset" <p>Pending messages in the generator are deleted.</p> <p>More information, (see "Displaying and resetting messages", pg. 61).</p>

Overview of expandable sidebar

Tab. 18

Main menu

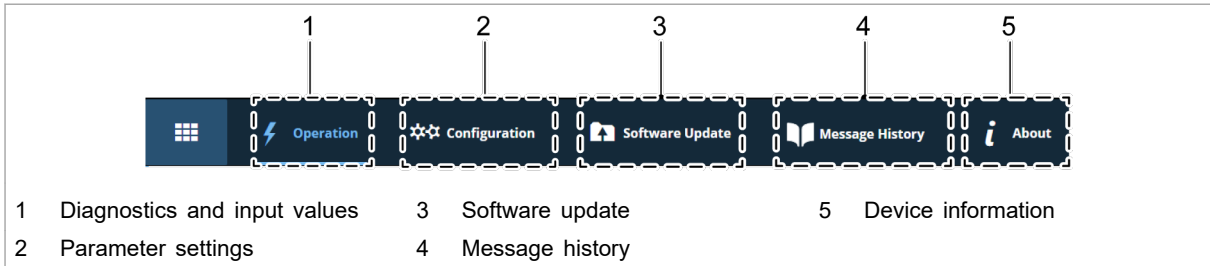

Main menu

Fig. 40

Input area Clicking on the submenu items opens the input area. Displayed here are the areas of the submenu items for reading or editing. Operation is explained in the individual chapters of the function descriptions.

Input functions:

- Selection fields
- Input fields
- Slide control

Input fields

A new entry is activated by pressing the Enter key.

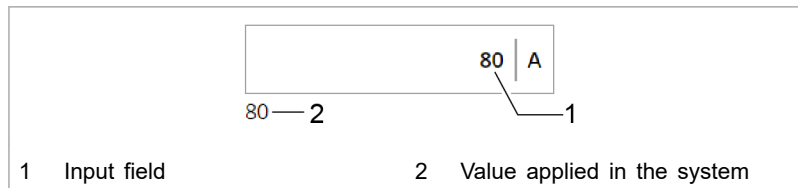

Confirm input

Fig. 41

Slide control

The slide control is moved with a simple click.

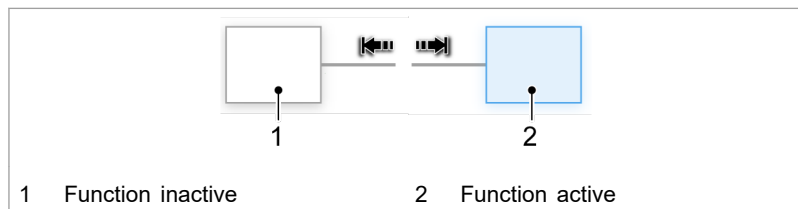



Slide control

Fig. 42

Menu structure

Global menu structure (expandable sidebar)

Main menu	Area	Description
Operation Settings 	<ul style="list-style-type: none"> ▪ >Change User Role. ▪ >Interface Control. 	<ul style="list-style-type: none"> ▪ Setting the user roles (For service only) ▪ Enabling interface, (see "Active interface", pg. 47).
System settings 	<ul style="list-style-type: none"> ▪ System clock and time setting ▪ Network settings 	<ul style="list-style-type: none"> ▪ (see "Setting the system time", pg. 75). ▪ (see "Changing network settings", pg. 75).
Messages 	>Pending messages	(see "Displaying messages of the web GUI", pg. 61).

Menu structure of the sidebar

Tab. 19

Menu structure of the main menu

Main menu	Submenu	Description
>Home	—	Start screen (see "Calling up the web GUI", pg. 48)
>Operation	>Device control DC-DC mode	(see "Transmission of power", pg. 60) (see "Actual values", pg. 70)
	>DC-DC module settings	(see "Set process set values (DC-DC module settings)", pg. 44)
	>Save & restore settings	(see "Saving parameters and resetting to factory settings", pg. 71)
>Configuration	>System configuration	(see "Setting the system configuration", pg. 73) (see "Communication timeout", pg. 47)
>Software Update	—	(see "Perform software update", pg. 77)
>About	—	(see "Displaying device information", pg. 77)

Menu structure of the web GUI

Tab. 20

7.4 Operation via Modbus

Protocol: TCP/UDP.

Differences for Modbus – user interface

Note

Operation via Modbus is the standard method of operation for regular operation.

Configuration, initial commissioning and software update of the TruConvert System Control and the connected modules can be performed via the user interface.

Function	User interface	Modbus
Operation	x	x
System configuration	x	x
Software update	x	—
Changing the IP address	x	—
Data backup	x	—

Differences in operation

Tab. 21

Instructions for using Modbus

Instructions and information for using Modbus are given mainly in this sub-chapter "Operation via Modbus". The individual Modbus registers and their description can be found in the Modbus Register Map (see "Modbus Register Map", pg. 54).

In cases where a more detailed explanation of the procedure via Modbus is required, an additional description for using Modbus is given in the chapter "Operation" of the general description (web GUI).

Establishing a connection

Condition

- Initial commissioning was performed (see "Commissioning", pg. 42).
1. Connect the TruConvert System Control to the Modbus master with an Ethernet cable.
 2. To switch on the system control and the modules: switch on the 24 V supply voltage.

The PCS (Power Conversion System) is ready for communication via Modbus.

Addressing modules via Modbus

Within a configuration consisting of the system control and multiple DC-DC modules, it is possible to address a specific module directly via the Modbus.

There are two ways to address a module:

- Addressing with register 4007 (default setting)
- Addressing via slave ID/unit ID (alternative)

Only one of the two options can be selected. It is not possible to use both simultaneously.

Addressing modules via Modbus register 4007

- To address a DC-DC module (slave modules), enter the following in register 4007:
 - 0 = Address all slave modules.
 - 1 – n = Address selected slave module.

Address modules via slave ID (unit ID)

1. Set Modbus register 4011 to 1.
2. To address a module directly in the Modbus register:
 - Specify the address of the desired module in field "Slave-ID".
 - Observe the structure of the module address.

Structure of the module address	Description
DC-DC module ("Slave-ID")	<ul style="list-style-type: none"> ▪ The slave ID has max. 3 digits (0 to 169). ▪ Slave ID = 1 to 16: The command is transmitted to the explicitly named slave (DC-DC module). ▪ Slave ID = 0: The command is transmitted to all connected slaves. ▪ Accesses to a slave register with slave IDs > 16 are ignored.

Definition: structure of the module address

Tab. 22

Modbus Register Map

- Base settings: address range 1000 to 1999
- Info system: address range 2000 to 2399
- Alarm and warning messages: address range 2400 to 3999
- Process set values: address range 4000 to 4999
- Process actual values: address range 5000 to 5999

Addr	Description	Unit	Resolution	Default	Min	Max	Data type	Type	Length	FCr	FCw
1000	Date	dd.m m.yy yy					UINT 32	Register	2	03	16
1002	Time	hh:m m:ss					UINT 32	Register	2	03	16
1004	IP address	xxx.x xx.xx x.xxx		0xC0 A801 02	1	0xFF FFF FFF	UINT 32	Register	2	04	
1006	Subnet	xxx.x xx.xx x.xxx		0xFF FFF F00	1	0xFF FFF FFF	UINT 32	Register	2	04	
1008	Gateway	xxx.x xx.xx x.xxx		0xC0 A801 01	1	0xFF FFF FFF	UINT 32	Register	2	04	
1010	Reset parameters to factory settings	-	1.0	0	0	1	UINT 16	Coil	1	01	05
1016	Master communication timeout (65535 disables mechanism)	s	1.0	10	1		UINT 16	Register	1	03	06
1017	Setting this flag will restart the CPU (only in idle or error state)	-	1.0	0	0	1	UINT 16	Coil	1	01	05
1018	Setting for connected system configuration: No config = 0, Simulator config = 1, DC-DC only config = 2, n*AC-DC m*DC-DC config = 3	-	1.0	0	0	6	UINT 16	Register	1	03	06
1026	1: triggerst automatic system software update (if necessary)			0	0	1	UINT 16	Register	1	03	06
1027	1: automatic system software update required			0	0	1	UINT 16	Register	1	04	
1028	Variable to save or reset customer values: 1: save parameter -1: restore default settings	-	1.0	0	-1	1	INT1 6	Register	1	03	06
2000	Serial number system control	String					UINT 32	Register	2	04	16
2002	Serial number DC-DC module	-	1.0		0		UINT 32	Register	2	03	16
2004	Material number DC-DC module	-	1.0		0		UINT 32	Register	2	03	16
4000	Power stage configuration: 1 = power stage on; 0 = power stage off;	-	1.0	0	0	1	UINT 16	Coil	1	01	05

Addr	Description	Unit	Resolution	Default	Min	Max	Data type	Type	Length	FCr	FCw
4002	Resets current alarm and warning messages	-	1.0	0	0	1	UINT 16	Coil	1	01	05
4007	Specifies the slave that will be addressed (0 = broadcast / same values for all slaves)	-	1.0	0	0	16	UINT 16	Register	1	03	06
4008	Error handling policy for systems with multiple slaves: 0 = relaxed (System keeps running even if some slaves are in error state.) 1 = strict (System shuts down as soon as one component is in error state.)	-	1.0	0			UINT 16	Register	1	03	06
4010	Specifies the sub slave that will be addressed (0 = broadcast / same values for all sub slaves)	-	1.0	0	0	16	UINT 16	Register	1	03	06
4011	Use the modbus slave ID for addressing	-	1.0	0	0	1	UINT 16	Coil	1	01	05
4100	Maximum battery voltage (charge current will get limited)	V	0.01	4800	0	7500	UINT 16	Register	1	03	06
4101	Minimum battery voltage (discharge current will get limited)	V	0.01	0	0	7000	UINT 16	Register	1	03	06
4102	Maximum battery voltage (charge current will get limited)	V	0.1	480	0	7000	UINT 16	Register	1	03	06
4103	Minimum battery voltage (discharge current will get limited)	V	0.1	0	0	7000	UINT 16	Register	1	03	06
4106	Maximum battery current during charging	A	0.1	700	0	700	UINT 16	Register	1	03	06
4109	Maximum battery current during discharging	A	0.1	700	0	700	UINT 16	Register	1	03	06
4112	Maximum voltage of voltage current characteristic	V	0.1	1000	1000	7000	UINT 16	Register	1	03	06
4115	Maximum current of voltage current characteristic	A	1.0	50	5	70	UINT 16	Register	1	03	06
4118	Start current of voltage current characteristic	A	1.0	5	1	10	UINT 16	Register	1	03	06
4121	Maximum power at DC-terminal	W	1.0	9000	0	30000	UINT 16	Register	1	03	06
4124	Maximum voltage alarm threshold for DC-terminal (power stage shutdown)	V	0.1	750	0	7100	UINT 16	Register	1	03	06
4127	Minimum voltage alarm threshold for DC-terminal (power stage shutdown)	V	0.1	0	0	7000	UINT 16	Register	1	03	06
4500	Set value for battery current in DcDc only operation	A	1.0	0	-70	70	INT16	Register	1	03	06

Addr	Description	Unit	Res- olu- tion	Defa ult	Min	Max	Data type	Type	Leng th	FCr	FCw
4501	Set value for allowed current dynamic in ampere per millisecond for DcDc only operation	A/ms	0.01	500	1	500	UINT 16	Reg- ister	1	03	06
4504	DC link control mode: 0 = OFF - standard current control active (according to battery current set value) 1 = DC link voltage static active (battery current dependent on DC link voltage)	-		0			UINT 16	Reg- ister	1	03	06
4505	Reference voltage of DC link voltage static (battery current = 0)	V	0.1	8500		9350	UINT 16	Reg- ister	1	03	06
4506	Upper voltage window of DC link static for battery charge current	V	0.1	400	100	1000	UINT 16	Reg- ister	1	03	06
4507	Lower voltage window of DC link static for battery discharge current	V	0.1	400	100	1000	UINT 16	Reg- ister	1	03	06
4508	Voltage deadband at reference voltage of DC link static	V	0.1	0		1000	UINT 16	Reg- ister	1	03	06
5000	State of device: PowerUP -> 0, Error -> 1, Idle -> 2, Operation -> 3, Maintenance -> 4	-	1.0	-1	-2	10	INT1 6	Reg- ister	1	04	
5001	Number of connected slave modules	cnt	1.0	0		16	UINT 16	Reg- ister	1	04	
5002	Number of connected sub slave modules	cnt	1.0	0	0	5	UINT 16	Reg- ister	1	04	
5100	Battery voltage	V	0.1		0	1200	UINT 16	Reg- ister	1	04	
5110	Battery current	A	1.0	0			INT1 6	Reg- ister	1	04	
5113	Total power of all DC modules	kW	0.00 1				INT3 2	Reg- ister	2	03	
5120	Power at DC-terminal	kW	0.00 1				INT1 6	Reg- ister	1	04	
5123	Status of battery current limiting control: 0 = inactive, 1 = PMax, 2 = IChargeMax, 4 = IDischargeMax, 8 = VBatMax, 16 = VBatMin. Multiple states are possible simultaneously (register = sum of active states)		1.0	0			UINT 16	Reg- ister	1	04	
5126	Overload capacity	%	0.1	0	0	1000	UINT 16	Reg- ister	1	04	
5127	DC link voltage	V	1.0	0	0	1300	UINT 16	Reg- ister	1	04	

Addr	Description	Unit	Res- olu- tion	Defa ult	Min	Max	Data type	Type	Len gth	FCr	FCw
5300	Status of battery current limiting control	String		inactive			STRING	Register	32	03	
5510	Temperature of inlet air DC-DC converter	°C	1.0	0	-25	250	INT16	Register	1	04	
5511	Temperature of HV module DC-DC converter	°C	1.0	0	-25	250	INT16	Register	1	04	
5512	Temperature of LV module DC-DC converter	°C	1.0	0	-25	250	INT16	Register	1	04	
2401	Sum of all pending warnings	Count			0		UINT16	Register	1	04	
2402	Count of pending module specific warnings	Count					UINT16	Register	1	04	
2403	Warning Code of Alarm 1						UINT16	Register	1	04	
2404	Warning Code of Alarm 2						UINT16	Register	1	04	
2405	Warning Code of Alarm 3						UINT16	Register	1	04	
2406	Warning Code of Alarm 4						UINT16	Register	1	04	
2407	Warning Code of Alarm 5						UINT16	Register	1	04	
2408	Warning Code of Alarm 6						UINT16	Register	1	04	
2409	Warning Code of Alarm 7						UINT16	Register	1	04	
2410	Warning Code of Alarm 8						UINT16	Register	1	04	
2411	Warning Code of Alarm 9						UINT16	Register	1	04	
2412	Warning Code of Alarm 10						UINT16	Register	1	04	
2413	Warning Code of Alarm 11						UINT16	Register	1	04	
2414	Warning Code of Alarm 12						UINT16	Register	1	04	
2415	Warning Code of Alarm 13						UINT16	Register	1	04	
2416	Warning Code of Alarm 14						UINT16	Register	1	04	
2417	Warning Code of Alarm 15						UINT16	Register	1	04	
2418	Warning Code of Alarm 16						UINT16	Register	1	04	
2419	Warning Code of Alarm 17						UINT16	Register	1	04	
2420	Warning Code of Alarm 18						UINT16	Register	1	04	
2421	Warning Code of Alarm 19						UINT16	Register	1	04	

Addr	Description	Unit	Res- olu- tion	Defa ult	Min	Max	Data type	Type	Len gth	FCr	FCw
2422	Warning Code of Alarm 20						UINT 16	Reg- ister	1	04	
2808	Sum of all pending alarms	Coun t			0		UINT 16	Reg- ister	1	04	
2809	Count of pending module specific alarms	Coun t					UINT 16	Reg- ister	1	04	
2810	Error Code of Alarm 1						UINT 16	Reg- ister	1	04	
2811	Error Code of Alarm 2						UINT 16	Reg- ister	1	04	
2812	Error Code of Alarm 3						UINT 16	Reg- ister	1	04	
2813	Error Code of Alarm 4						UINT 16	Reg- ister	1	04	
2814	Error Code of Alarm 5						UINT 16	Reg- ister	1	04	
2815	Error Code of Alarm 6						UINT 16	Reg- ister	1	04	
2816	Error Code of Alarm 7						UINT 16	Reg- ister	1	04	
2817	Error Code of Alarm 8						UINT 16	Reg- ister	1	04	
2818	Error Code of Alarm 9						UINT 16	Reg- ister	1	04	
2819	Error Code of Alarm 10						UINT 16	Reg- ister	1	04	
2820	Error Code of Alarm 11						UINT 16	Reg- ister	1	04	
2821	Error Code of Alarm 12						UINT 16	Reg- ister	1	04	
2822	Error Code of Alarm 13						UINT 16	Reg- ister	1	04	
2823	Error Code of Alarm 14						UINT 16	Reg- ister	1	04	
2824	Error Code of Alarm 15						UINT 16	Reg- ister	1	04	
2825	Error Code of Alarm 16						UINT 16	Reg- ister	1	04	
2826	Error Code of Alarm 17						UINT 16	Reg- ister	1	04	
2827	Error Code of Alarm 18						UINT 16	Reg- ister	1	04	
2828	Error Code of Alarm 19						UINT 16	Reg- ister	1	04	
2829	Error Code of Alarm 20						UINT 16	Reg- ister	1	04	

Modbus Register Map

Tab. 23

7.5 Transmission of power

Switching the transmission of power on/off

Conditions

- Initial commissioning was performed (see "Commissioning", pg. 42).
- Operation via web GUI and/or Modbus.

Enter process set values

1. Selection of a DC-DC module (only relevant if multiple modules are connected to a TruConvert System Control).
 - Select *>Operation >Device control DC-DC mode*.
In the "Module selection" area under "Select slave module", select a module.
 - Modbus: (see "Modbus Register Map", pg. 54)
Enter the number of the module to be addressed.

Note

User interface and Modbus may have different scaling. For Modbus parameters, the resolutions specified in the Modbus Register Map must be taken into account (see "Modbus Register Map", pg. 54).

For example:

Enter 100 A for parameter "Max. charging current, DC module 1" with resolution 0.1:

Input via web GUI: 100.0

Transfer via Modbus: 1000.

2. Enter the set value for the battery current.

Charge battery: enter negative value.

Discharge battery: enter positive value.

- In the "Device control DC-DC" area under "Set value battery current", enter the value³.
Press key ↵.
3. Enter the maximum permitted battery current change under "Battery current slope".

Start transmission of power

4. Start transmission of power.
 - Select *>Operation >Device control DC-DC mode*.
Under "Activate power stage": click on the slide control.
 - Modbus: (see "Modbus Register Map", pg. 54)
For the Modbus register for power operation, set bit = 1.
The regulator slides to the right and is displayed in blue.

³ In the user interface, a period character is used as the decimal separator.

Stop transmission of power

5. To stop the transmission of power:
 - Under "Activate power stage": click on the slide control..
 - Modbus: (see "Modbus Register Map", pg. 54)
For the Modbus register for power operation, set bit = 0.

Starting/stopping power transmission for other DC-DC modules

6. Starting/stopping power transmission for other DC-DC modules
 - Select another DC-DC module (via user interface or slave address via Modbus) and perform the previous steps again.

or

 - To switch on all DC-DC modules simultaneously:
 - In the "Module selection" area under "Select slave module", select = "All modules".
 - Modbus: (see "Modbus Register Map", pg. 54)
Enter the number of the slave to be addressed = "0".
 - Start transmission of power.



7.6 Displaying and resetting messages

Displaying messages of the web GUI

There are various options for reading the pending messages:

- Status bar: type and number of pending messages, .
- "Message History" main menu, : type, code, module, date/time.
- Expandable sidebar: type, number, code, module, date/time and message text.

Displaying messages

If a message is pending, the icon for messages in the sidebar  is colored orange or red . If there are any warnings present, the icon is orange. If at least one alarm is pending, the icon is colored red.

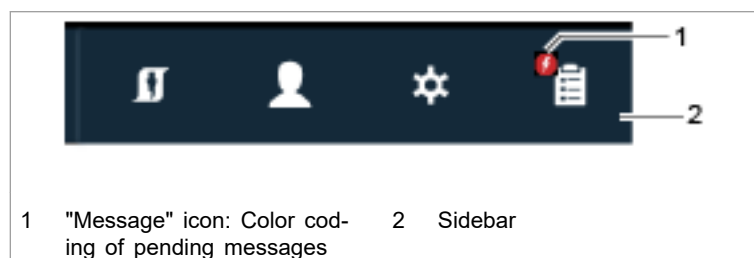

Sidebar, collapsed

Fig. 43

1. In the sidebar, click on the  icon to display the messages.

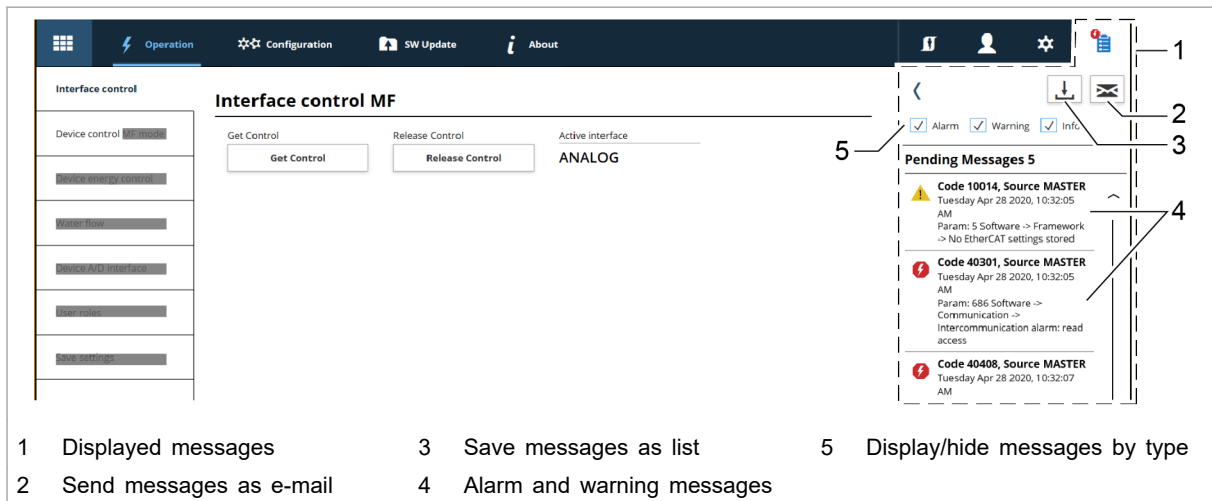

Sidebar, expanded

Fig. 44

A message consists of 3 components: "Code" (message number), "Source" (originator) and message text.

- The module that has caused the message is indicated by the description and number in the "Source" field.

MASTER = System control

- SLAVE = DC-DC module

Each slave number has 4 digits. The first 2 digits stand for the slave modules (DC-DC modules) connected to the system control; the 3rd and 4th digits are irrelevant.

Example:

Source SLAVE 0200 → DC-DC module 02 caused the message.

- If TRUMPF Service is to be contacted, it is recommended to note down the message number.

Tip

To display the window of the sidebar larger: click on the left arrow.

To hide the window of the sidebar: click on the active icon again.

Download alarm list

2. To download a list of all alarm messages that have occurred:
 - Press the "Meldungen als Liste speichern" (3) button.
 - Save as a csv file.
3. To generate a prepared e-mail to TRUMPF Service:
 - Press the "Meldungen als E-Mail verschicken" (2) button.
 - Press "Save " download to save the zip file on the PC.
 - The e-mail program opens and displays a prepared e-mail.
 - Attach the zip file saved under >Downloads on the PC.

- Reset messages**
4. In the sidebar, click on the  icon to display the messages.
 5. Press "Reset".
The icon turns white again. All messages are reset.
 6. Hide messages:
To hide the window of the sidebar: click on the active icon again.

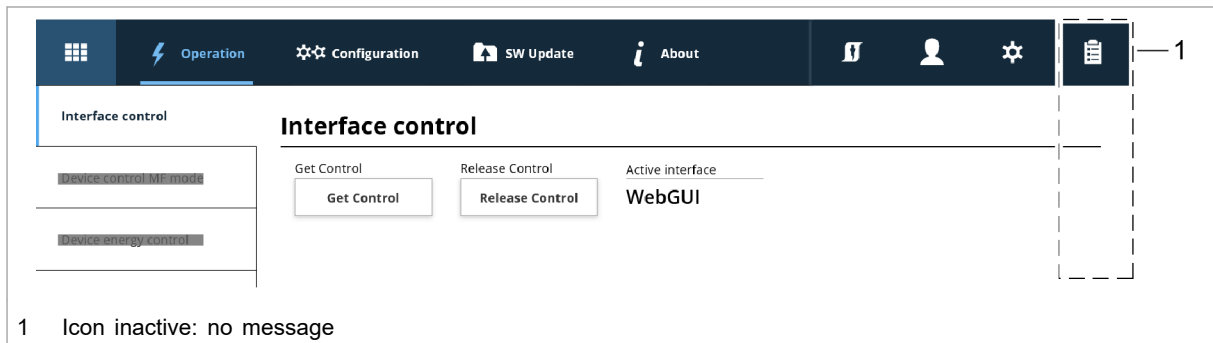

Sidebar, collapsed, no messages

Fig. 45

7. To reset the messages of a specific module:
 - Select *>Operation >Device control DC-DC mode*.
 - In the "Module selection" area under "Select slave module", select a module.
 - In the "Device control DC-DC" area, press "Reset alarms".

All messages of the selected module are reset.

If the message is not reset:

- If MASTER is displayed under "Source", select "All modules" under "Select slave module". All messages are reset, including the messages from the master (system control).
- If SLAVE 1 is display under "Source", select "Module 1" under "Slave module selection" in order to reset only the messages from slave 1 and its subslaves.

Modbus: displaying and resetting messages

There are three different types of message: alarm, warning and info.

The number of pending messages can be queried by message type and the message numbers read out. The messages can then be assigned to the DC-DC module that caused the message.

Displaying the number of pending messages

1. Read out the number of current alarm/warning/info messages that have occurred on the entire system (see "Modbus Register Map", pg. 54).

Slave address = 0

The number of all messages that occurred in the system is output.

2. Read out the number of current alarm/warning/info messages that have occurred on an individual DC-DC module.

Slave address = 1 to n

The number of messages that occurred at this DC-DC module is output.

Reading out message numbers

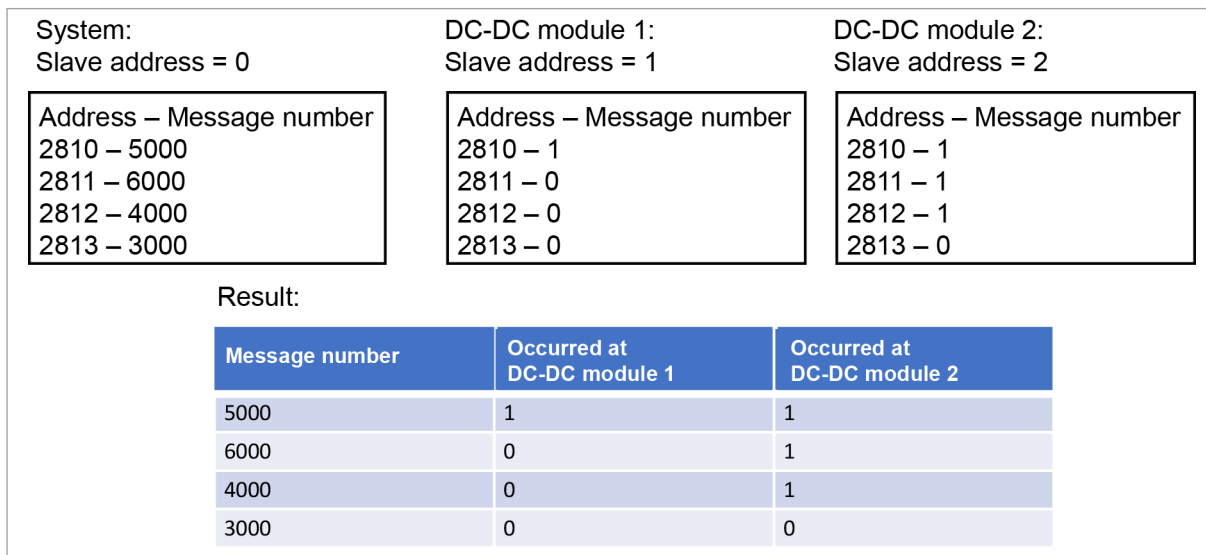

Read out messages and assign to respective DC-DC module

Fig. 46

3. Read out message numbers (alarm/warning/info messages 1 to 20) that have occurred on the entire system.

Slave address = 0

All message numbers of the messages that occurred in the system are output in an overview list. The message numbers are output in the order in which they occurred.

4. Read out message numbers (alarm/warning/info messages 1 to 20) that have occurred on an individual DC-DC module.

Slave address = 1 to n

Output for each DC-DC module are the messages that occurred in the system and were caused by the respective DC-DC module. The address represents the message number that was stored there in the overview list (slave address = 0). The value stored at this address can be 0 or 1.

Value = 1, this message is pending at the DC-DC module.

Value = 0, this message is not pending at the DC-DC module.

- Reset messages**
5. Reset all messages (see "Modbus Register Map", pg. 54):
 - Slave address = 0
 - Value = 1

All messages are reset. No further messages are pending.

If the cause of a message persists, this message is displayed again.

7.7 Overload

To permit load peaks when starting up motors or when starting devices, the modules can be operated in overload operation. This method of operation is permissible only for a short time and is regulated accordingly by the system.

The overload is monitored and regulated separately for each phase.

Examples: Reduce and then again increase overload capacity

Reduce overload capacity from 100% to 0%

The overload capacity drops from 100% to 0% if the system is operated at overload with:

- A battery current or a battery power between 100% and 125% (the higher value is relevant).
For 10 minutes.
- or
- A battery current or a battery power between 125% and 150% (the higher value is relevant).
For 1 minute.

Increase overload capacity again from 0% to 100%

The overload capacity increases again from 0% to 100% if the system is operated under normal load with:

- A battery current or a battery power < 90%.
For 20 minutes.
- or
- A battery current or a battery power < 80%.
For 10 minutes.

7.8 DC voltage droop

Function description of DC voltage droop

Current source, voltage-dependent current source

The TruConvert DC series 1000 devices are designed as current sources. Using the DC voltage droop function, they can also be operated as a voltage-dependent current source.

"DC voltage droop" function	DC-DC module operating as
Not activated	Current source
Activated	Voltage-dependent current source

Effect of DC voltage droop function

Tab. 24

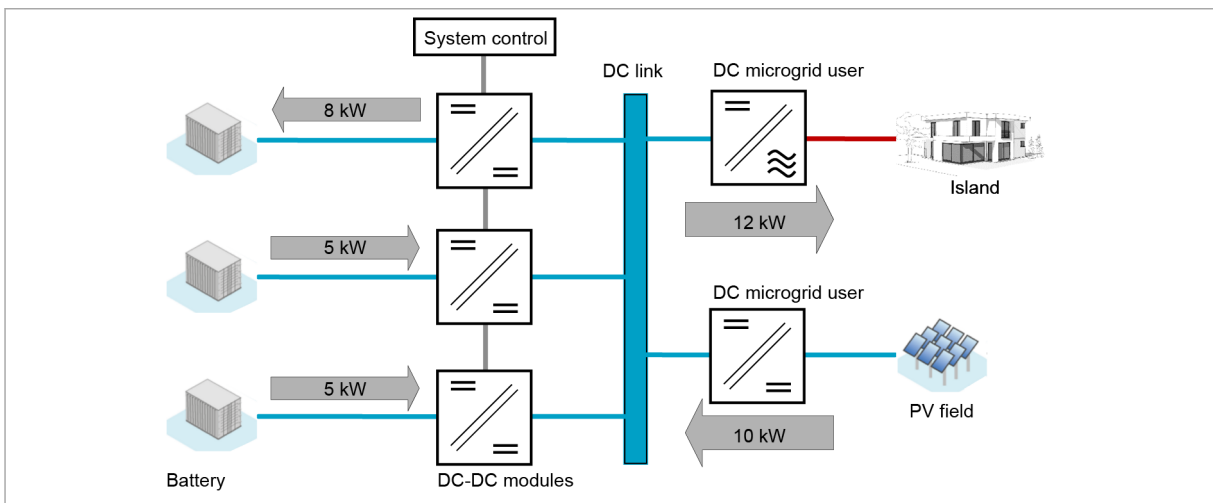

Example: System control with subordinate DC-DC modules. (Efficiency disregarded.)

Fig. 47

"DC link voltage droop mode"

The function adjusts the battery current depending on the DC link voltage. In this way, the DC link voltage can be stabilized with multiple, parallel-connected DC-DC modules without high-speed data communication being necessary.

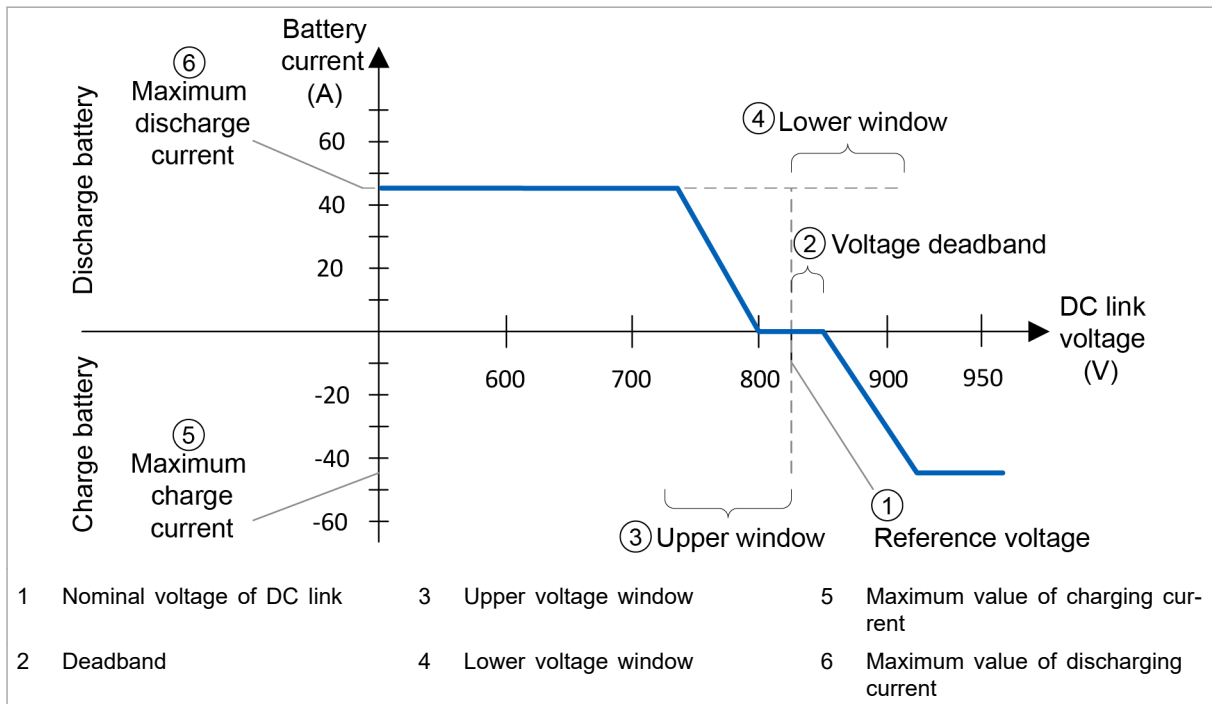

Battery current as a function of DC link voltage (DC voltage droop)

Fig. 48

The nominal DC link voltage "Reference voltage" (1) defines the reference voltage at which the battery current is 0 A.

By adjusting the voltage gap "Voltage deadband" (2), an overall deadband can be defined in which the battery current remains at 0 A. This can be helpful in creating a hierarchy if multiple DC-DC modules are connected in parallel. The overall deadband is symmetrical about the reference voltage. If e.g. "Voltage deadband" is set to 5 V, this results in an overall deadband of 10 V about the reference voltage.

Note

At least 1 DC-DC module or DC link participant must have a straight characteristic curve without deadband. Otherwise the nominal voltage under no-load is not defined.

The upper window "Upper window" (3) and the lower window "Lower window" (4) define the voltage range over which the battery current is set as a function of the DC link voltage.

The maximum values for charging and discharging current (5,6) define the upper and lower current limit of the characteristic curve.

All parameters that define the voltage windows can be set individually for each DC-DC module. The voltage windows do not have to be symmetrical; the value for the maximum charging current can deviate from the value for the maximum discharging current.

Switching on DC voltage droop

The DC droop can be switched on and off during running operation. It can be adjusted individually for each connected DC-DC module.

Via user interface

1. Select *>Operation >Device control DC-DC mode*.
2. To set the parameters for this function:
 - Enter the desired values in the "DC link voltage droop mode settings" area.

Parameter description: (see ["Parameterization of DC voltage droop"](#), pg. 68).

3. In the "DC link voltage droop mode settings" area under "DC link voltage droop mode", select "on".

The function is switched on.

Via the Modbus

4. To set the parameters for this function:
 - In register area 4505 – 4508, enter the desired values.

Parameter description: (see ["Parameterization of DC voltage droop"](#), pg. 68).

5. To activate the "DC link voltage droop mode" function, enter the following in register 4504:
 - 1 = "DC link voltage droop mode" is active.

Parameterization of DC voltage droop

All adjustable parameters are listed in the following table.

Parameter	Description	Unit	Adjustment range		Factory settings	Step size
			Minimum	Maximum		
DC link droop mode Register 4504	Parameter activates/deactivates the "DC link voltage droop mode" function.	–	0	1	0	1
Reference voltage Register 4505	Reference voltage at which the battery current is 0 A.	V	0	935	850	0.1
Upper window Register 4506	Upper voltage window	V	0	100	40	0.1

Parameter	Description	Unit	Adjustment range		Factory settings	Step size
			Minimum	Maximum		
Lower window Register 4507	Lower voltage window	V	0	100	40	0.1
Voltage deadband Register 4508	Deadband; within this range, the battery current remains 0 A. (Overall deadband = 2 x deadband)	V	0	100	0	0.1

Adjustable parameters for "DC link voltage droop mode"

Tab. 25

The limit values for the battery current can be set in exactly the same way as in the standard current source mode (see "Process set values", pg. 71).

Parameter	Description
Upper window Lower window	<p>Slope of droop</p> <p>The slope of the droop must match the physical properties of the set-up DC grid (total capacitance, existing impedances and, where applicable, active participants). If the factory settings for "Upper window" or "Lower window" do not apply to your application case, contact TRUMPF Service</p> <p>Parameters cannot be changed during running operation.</p>
Reference voltage Upper window	<p>Upper voltage limit of droop</p> <p>Participants in a DC grid can have different voltage limits. The upper voltage of the set characteristic curve must not exceed the lowest overvoltage limit in the system.</p> <p>Reference voltage + Upper window ≤ lowest overvoltage limit</p>
Reference voltage Lower window	<p>Lower voltage limit of droop</p> <p>The DC link voltage must satisfy the following conditions:</p> <ul style="list-style-type: none"> ▪ If the DC-DC modules are subordinate to an AC-DC module, the DC link voltage must be at least twice the peak value of the voltage. <ul style="list-style-type: none"> - Grid with 400 V ±10 % \triangleq 720 V. - Grid with 480 V ±10 % \triangleq 870 V. ▪ If the DC-DC modules are subordinate to a system control, the DC link voltage must be at least 50 V above the battery voltage. ▪ Reference voltage - Lower window ≥ lowest lower voltage limit

Description of the parameters

Tab. 26

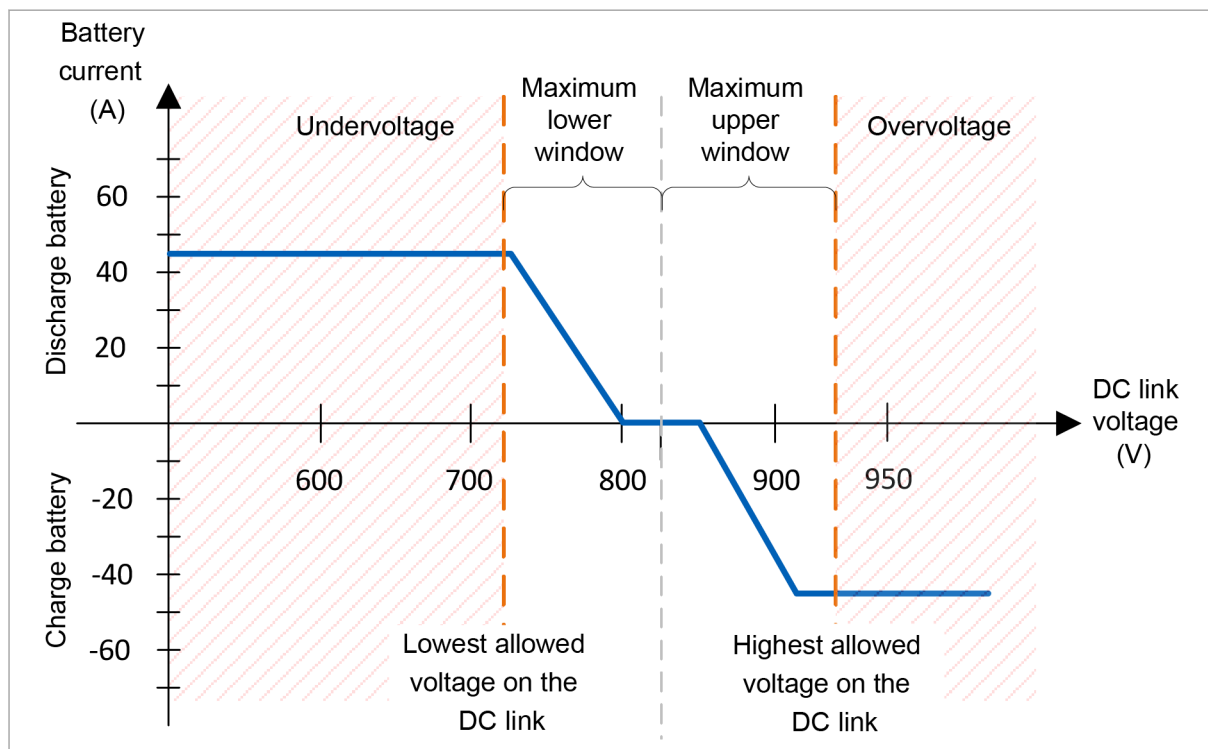

Example: Upper and lower voltage limit of permitted operation

Fig. 49

Entering parameters for DC droop

1. Select *>Operation >DC-DC module settings*. Enter the desired values in the "DC link static mode settings" area.
2. Or: Set parameters via Modbus registers (see "Modbus Register Map", pg. 54).

7.9 Actual values

Display actual values

1. Select *>Operation >Device control DC-DC mode*.

Note

Some actual values can only be displayed if a specific DC-DC module was selected. To display the actual values for battery voltage, DC link voltage and temperature, the slave module to be addressed must be explicitly selected. E.g. "Select slave module" = "Module 1"

If all modules are selected as addressees ("Select slave module" = "All modules"), 0 is displayed for these actual values.

2. Either

- To display the actual values for an individual DC-DC module: In the "Module selection" area under "Select slave module", select a module..

or

- To display the actual values for the entire system: In the "Module selection" area under "Select slave module", select "All modules"..

3. In the "Status DC interface" area, read off the actual values:

- Current battery values: "Battery current", "Battery voltage".
- Currently intervening regulator: Under "Current limiting status", read off the active regulator.
Possible regulators: Pmax, max. charging current, max. discharging current, max. battery voltage and min. battery voltage.
- Current DC link voltage: "DC link voltage".

4. Display the current temperatures: In the "Device temperatures" area, read off the actual values.

- HV module: High-voltage power module inside the DC-DC module.
- LV module: Not used
- Air inlet: Inflow for air cooling.

7.10 Process set values

Set process set values

- Set the process set values via the web GUI: (see "Set process set values (DC-DC module settings)", pg. 44).

or

- Set the process set values via Modbus registers: (see "Modbus Register Map", pg. 54).

7.11 Data backup



Saving parameters and resetting to factory settings

All general settings that were made under *>Operation >DC-DC module settings* with "Select slave module" = "All modules" can be stored in the device and are retained following a restart as well as after switching the device off and back on again.

The general settings can be exported as a json file and then imported into another device.

Individually generated settings for single modules ("Select slave module" = "Module 1" to "Module n") cannot be stored.

Conditions

- Operation via web GUI
 - Settings to be saved are entered under *>Operation >DC-DC module settings* for "Select slave module" = "All modules".
1. Select *>Operation >Save & restore settings*.
 2. In the "Save & restore settings" area under "Customer settings", select "Save" to save the current settings in the TruConvert System Control.
 3. In the "Save & restore settings" area under "Customer settings", select "Restore" to restore the factory settings.
 4. To save the current settings as a file on a hard drive of the PC:
 - In the "Import & export parameters" area under "Export parameters", press "Download".
 - In the browser window that opens, select "Save as".
 5. In the "Import & export parameters" area, press  to search for and select a file on a hard drive of the PC.
 6. To load the selected file to the system control:
 - Press the  button to upload the file.
 - To permanently save the settings in the TruConvert System Control: In the "Save & restore settings" area under "Customer settings", select "Save".

7.12 System configuration

If the combination of devices connected to the system control is changed, the new system configuration must then be entered via the web-based user interface.

Setting the system configuration

Conditions

- Operation via web GUI
- Devices (AC-DC module, DC-DC modules) are connected to the system control

- Switching on devices**
1. To switch on the system control and the modules: switch on the 24 V supply voltage.

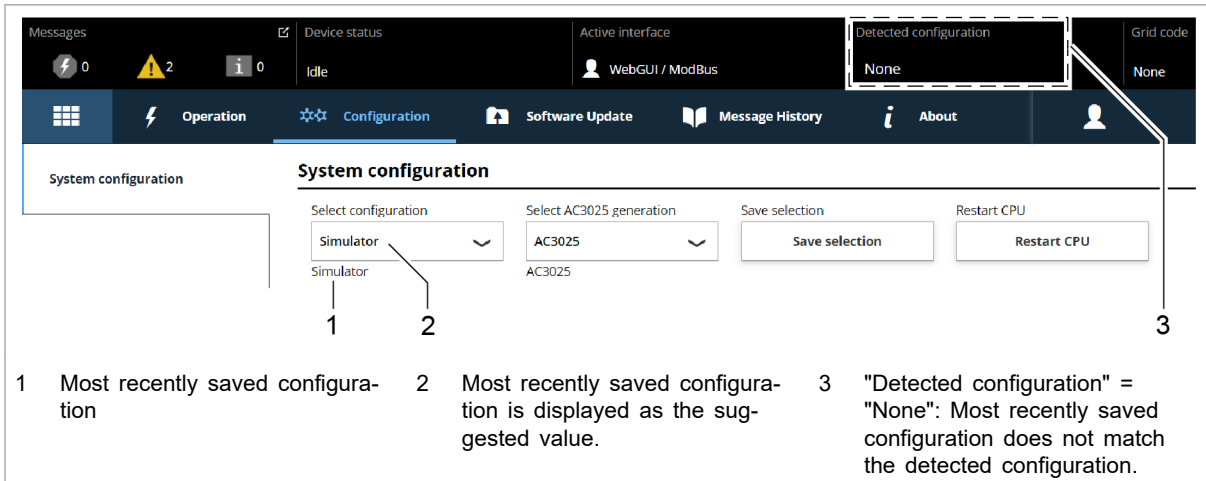

Input screen "System configuration"

Fig. 50

The input screen "System configuration" is displayed.

The connected devices do not match the expected configuration, i.e. the most recently saved configuration.

Status LEDs on the system control: All 3 LEDs blink synchronously.

Status LEDs on the DC-DC module: The green and red LEDs light up and the yellow LED flashes.

- Setting the system configuration**
2. Select *>Configuration >System configuration*.

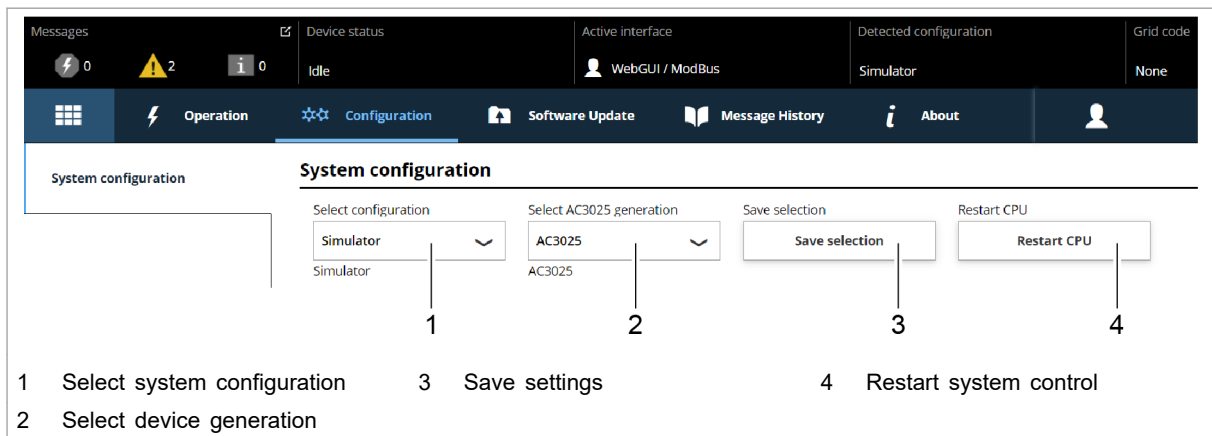

Screen: Set system configuration

Fig. 51

3. In "Select configuration", select the present system configuration:
 - No configuration
This configuration only occurs in the event of an error, e.g., if there is no connection to the modules (check cables) or if an incorrect module type was detected (check alarm messages).
 - Simulator
The system control alone is used and connected modules are simulated.
 - DC-DC configuration
Only DC-DC modules are connected to the system control.
 - $n*(AC-DC + m*DC-DC)$
AC/DC and DC/DC modules are connected to the system control.
4. Under "Select AC3025 generation", select the device generation: "AC3025".
5. To save the selection: press "Save selection".
6. To restart the TruConvert System Control: press "Restart CPU".

The system control balances the set system configuration with the actually connected modules. If both values match, the set system configuration is displayed in the status bar under "Detected Configuration".

If the set system configuration differs from the automatically detected system configuration, "None" is displayed in the status bar under "Detected Configuration". In addition, a message is output. Press  in the sidebar to display the messages.

Status LEDs on the DC-DC module and system control: The LEDs remain off immediately after the restart. The green LED begins to flash after a few seconds.

The system is ready for operation: It is in the "Idle" operating state and the start screen is displayed.

7.13 System settings

Setting the system time

User interface As soon as the device is connected to the PC, the local time of the PC is converted to UTC and adopted in the system control as system time.

In addition, adoption of the system time can also be triggered manually.

1. In the sidebar, click on "Settings" ✨.
The sidebar is displayed.
2. To adopt the system time from the PC for the device, press "Synchronize to local computer".
The system time of the PC is displayed on the user interface ("Show advanced settings") and transferred to the device.
3. To make your own settings: Press "Show advanced settings" in the "Time and date" area.
 - Under "Time zone", select the desired time shift relative to UTC.
 - Use the "Time format" slide switch to select between 24-hour display and 12-hour display.
 - Under "Time" and "Date", enter the desired time and the date.
 - Then press "Submit time and date".

Changing network settings

Note

Network settings can only be changed via the web GUI.

- Changing the IP address**
1. In the sidebar, click on "Settings" ✨.
 2. In the "Network" area under "IP address", enter new values.
IP address of the device on delivery:
 - 192.168.1.2
 3. Note the new IP address so as to be able to access the device via the user interface.

4. Press "Submit network settings".

The network settings are transferred to the device.

5. To restart the system control: press "Reboot".

Using the Reset button to reset the IP address

If the IP address of the device was changed and is not known, the IP address can be reset to the factory settings with the help of the Reset button.

Notice: This function can also be used to reset all customer parameters to the factory settings.

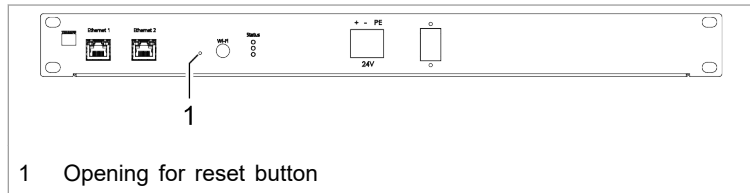

1 Opening for reset button

Fig. 52

6. Insert a small pen tip or piece of wire into the opening for the Reset button and press the Reset button.
 - Press for 3-5 seconds: IP address is reset to the factory settings.
 - Press and hold for 10 seconds: all device parameters are reset to factory settings.

After the reset, the operating panel automatically performs a restart.

Changing network settings (IP subnet and gateway)

7. In the sidebar, click on "Settings" ⚙️.
8. In the "Network" area, enter new values.

Input field	Value	Description
"Host address"	Text field	The device can be given an individual name. This name instead of the IP address can be entered in the web browser in order to access the device.
"DHCP client"	OFF	The device receives a fixed IP address. The IP address is entered in the "IP address" input field.
	ON	The DHCP client is enabled and receives an IP address from the customer DHCP server.
"IP address"	192.168.1.3 (example)	The IP address is used to integrate the device in a network. The IP address can be entered in the web browser in order to access the device.
"Subnet mask"	255.255.255.128 (example)	Set the same subnet mask as that on the higher-level system control.

Input fields for network settings

Tab. 27

9. Press "Submit network settings".

The network settings are transferred to the device.



10. To restart the system control: press "Reboot".

7.14 Software update

Perform software update

Conditions

- Operation via web GUI
- Zip file with new software stored on PC.

1. Select *>Software Update* .
2. In the "Software update" area, press the  button and open the zip file.
3. Press the  button to upload the zip file.

If the update was performed successfully, the system control automatically performs a restart.

Tip

To ensure that the new software is adopted error-free, perform a manual restart of the generator.

7.15 Device information

Displaying device information

System control

1. Select *>About*.
2. In the "Software package" area, read the details on the installed software package.
Relevant details are: "Integration level" and "Buildnumber".
3. In the "System control" area, read off the individual items of information for the system control:
 - Under "Software version application" and "Software version bootloader": the software versions on the system control (part of the "Software package").
 - Under "Serial number": the serial number of the system control.

Reading off software version and serial number

4. In the "Module selection" area, read off the number of available DC-DC modules under "Available slave modules".
The DC-DC module, which is directly connected to the system control with the data cable, is "Module 1". The next DC-DC module, which is connected to data output "OUT" of "Module 1", is "Module 2", etc.
5. Under "Select slave module", select the desired DC-DC module.
6. In the "DC-DC module" area under "Software version application" and "Software version bootloader", read off the software versions on the DC-DC module (part of the "Software package").
7. Under "Serial number", read off the serial number of the DC-DC module.

Tip

The serial numbers of the system control and the modules can also be queried via Modbus (see "Modbus Register Map", pg. 54).

7.16 State diagram

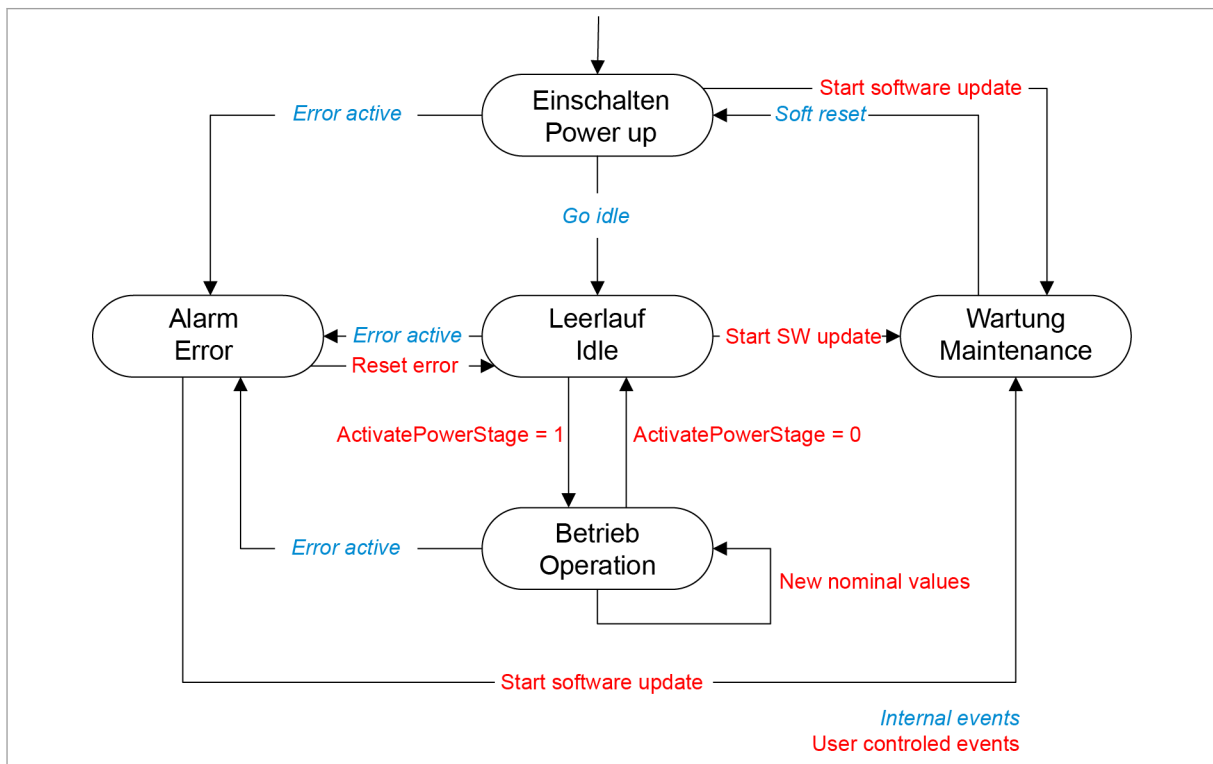

State machine

Fig. 53

8. Maintenance

Note

Housing must not be opened

The housing of the generator is sealed with stickers. Damage to the seals or the opening of the housing will invalidate the warranty.

8.1 Periodic check of the environmental conditions

In the event of poor environmental conditions, e.g. air with oil, dust and conductive parts, the fans may draw in particles that damage the module. The environment should therefore be kept as clean as possible.

8.2 Cleaning

If necessary, clean the module with a dry cloth.

8.3 Exchanging fans

The operating hours of the fan are counted. After the allowed running period is up, the module outputs a message.

TRUMPF recommends replacing the ventilator after an operation lifetime of 6 years.

- Only have fans exchanged by TRUMPF personnel or trained staff.

8.4 Performing software updates

Software updates can only be made via the user interface.

- Have software updates for the PCS performed by TRUMPF personnel only; if you perform the updates yourself, consult with TRUMPF personnel beforehand.

9. Troubleshooting

9.1 Fault indication and messages

Faults are displayed at different positions:

- Status LEDs on the DC-DC module.
- Status LEDs on the TruConvert System Control.
- On the web-based user interface.
- Via the Modbus.

Fault indication with the LEDs

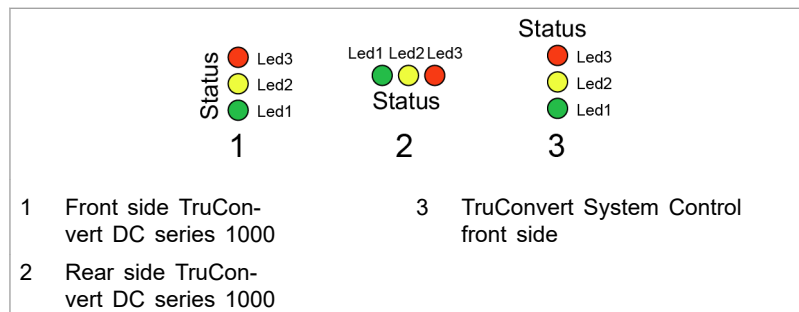

Status LEDs

Fig. 54

LED	Errors
1 (green)	off
2 (yellow)	off
3 (red)	Flashing

Display of the status LEDs in the event of a fault

Tab. 28

9.2 Messages

A distinction is made between alarm messages and warning messages.

Alarm message Power operation is automatically shut off if serious errors occur. The PCS switches to the alarm state and outputs an alarm message. Power operation can only be restarted after the cause of the alarm has been removed and the alarm message has been reset (see "State diagram", pg. 78).

Warning message In case of less severe faults, the power operation is not interrupted, but a warning message is issued.

Display of alarm and warning messages

The messages that are output always consists of an alarm or warning number and a message text.

When operating the device with the web GUI, the alarm and warning numbers are displayed together with the message text. In case of control with Modbus, only the numbers and no text are transmitted.

Resetting alarm and warning messages

(see ["Displaying and resetting messages"](#), pg. 61)

List of alarm and warning messages

The following tables show the most important alarm and warning messages, with notes on error causes and how to correct them.

If a message reappears repeatedly after resetting and restarting the device, please contact TRUMPF Service.

If a message appears whose number is not listed in the table, please also contact TRUMPF Service.

Alarm messages

Number	Message	Effect	Cause	Action	Detected by
40300	RS-485 communication alarm.	No operation possible.	Communication problem on RS-485 bus.	Check RS-485 communication.	System control
40301	RS-485 communication alarm.	No operation possible.	Communication problem on RS-485 bus.	Check RS-485 communication.	System control
40302	Active interface (Modbus or WebGUI) communication timeout has occurred	No operation possible.	Active interface (Modbus or WebGUI) communication timeout has occurred	Check active interface (Modbus or WebGUI) or disable timeout.	System control
40303	RS-485 communication alarm.	No operation possible.	Communication problem on RS-485 bus.	Check RS-485 communication.	System control
40304	No slave module was found, please check RS-485 connection(s).	System cannot finish start-up procedure	No slave module was found.	Check RS-485 connection(s) and modules.	System control
40305	Number of or combination of connected slave types not supported.	System cannot finish start-up procedure	Number of or combination of connected slave types not supported.	Check module configuration. Only homogeneous modules are allowed on one RS-485 bus.	System control
40412	Software versions of system control and module(s) do not match.	System cannot finish start-up procedure	Software versions of system control and module(s) do not match.	Software update necessary.	System control
40413	Software versions of system control and module(s) do not match.	System cannot finish start-up procedure	Software versions of system control and module(s) do not match.	Software update necessary.	System control
40414	Software versions of system control and module(s) do not match.	System cannot finish start-up procedure	Software versions of system control and module(s) do not match.	Software update necessary.	System control
40415	Software versions of system control and module(s) do not match.	System cannot finish start-up procedure	Software versions of system control and module(s) do not match.	Software update necessary.	System control
40416	Software versions of system control and module(s) do not match.	System cannot finish start-up procedure	Software versions of system control and module(s) do not match.	Software update necessary.	System control
60090	Battery overvoltage.	No operation possible.	Battery voltage too high.	Check battery voltage.	DC-DC module
60093	DC link overvoltage.	No operation possible.	DC link voltage too high.	Check DC link.	DC-DC module
60102	DC link voltage too low for operation.	No operation possible.	DC link voltage too low.	Check DC link pre-charge.	DC-DC module
60129	Battery voltage under threshold setting.	No operation possible.	Battery voltage under threshold setting.	Change battery threshold setting.	DC-DC module

Number	Message	Effect	Cause	Action	Detected by
60132	RS-485 communication alarm.	No operation possible.	Communication problem on RS-485 bus.	Check RS-485 communication.	DC-DC module
60142	Battery undervoltage.	No operation possible.	Battery voltage too low.	Check battery voltage.	DC-DC module
60145	Wrong polarity on DC terminal detected.	Risk of damaging hardware.	Wrong polarity on battery detected.	Check battery polarity.	DC-DC module
60150	Battery voltage over threshold setting.	No operation possible.	Battery voltage over threshold setting.	Change battery threshold setting.	DC-DC module
60168	Ambient temperature over allowed range.	No operation possible.	Ambient temperature over allowed range.	Check the ambient temperature.	DC-DC module
60186	Ambient temperature under allowed range.	No operation possible.	Ambient temperature under allowed range.	Check the ambient temperature.	DC-DC module
60192	Fan defective or stuck.	No operation possible.	Fan is defective or stuck.	Check fan.	DC-DC module
60200	Precharge conditions could not be met.	No operation possible.	Precharge conditions could not be met.	Check droop-mode settings, DC link and battery voltage.	DC-DC module
60201	Attached load on DC link can not be handled.	No operation possible.	Attached load on DC link can not be handled.	Reduce DC link load or change precharge procedure.	DC-DC module
60202	DC link could not be charged	No operation possible.	DC link could not be charged	Check DC link and connected components.	DC-DC module
60700	Auxiliary supply overvoltage.	Risk of damaging hardware.	Auxiliary supply voltage too high.	Check the external 24-V auxiliary supply.	DC-DC module
60703	Auxiliary supply undervoltage.	Unstable system.	Auxiliary supply voltage too low.	Check the external 24-V auxiliary supply.	DC-DC module

Alarm messages

Tab. 29

Warning messages

Number	Message	Caused by
10016	Powerfail of 24 V auxiliary supply has been detected	System control
11000	battery voltage < minimum reference or battery voltage > maximum reference	DC-DC module

Warning messages

Tab. 30

