

Operator's manual

**TruConvert DC series 1000,
TruConvert System Control**

TruConvert Modular

Operator's manual

**TruConvert DC series 1000,
TruConvert System Control**

TruConvert Modular

Original operator's manual

Edition **2020-11-26**

Order Information

Please specify when ordering this document:

Operator's manual

TruConvert DC series 1000, TruConvert System Control

Edition 2020-11-26

Document number A67-0140-00.BKen-001-06

Address for orders

TRUMPF Hüttinger GmbH + Co. KG

Technische Redaktion

Bötzingen Straße 80

D-79111 Freiburg

Fon: +49 761 8971 - 0

Fax: +49 761 8971 - 1150

Internet: <http://www.trumpf-huettinger.com>

E-Mail: info.elektronik@de.trumpf.com

Good to know

Need help? Provide the **serial number** when you contact the Service department. The serial number can be found on the name plate of the device.

How to reach our Service department:

Telephone +49 761 8971-2170

Fax +49 761 8971-1178

E-mail Service.Elektronik@de.trumpf.com

Chapter 1

Safety

1	Safety	1-3
1.1	Important notes	1-3
1.2	Storing the operating instructions	1-3
1.3	Warning signs	1-3
2	Using the DC-DC module	1-5
3	Authorized personnel	1-6
4	Warning signs on the DC-DC module	1-7
5	What you must know as an operator	1-8
6	Dangers from high voltages	1-9
6.1	Protective measures taken by the manufacturer	1-9

7	What you must know as an operator	1-10
7.1	Ensuring safe operation of the DC-DC module	1-10
7.2	Check periodically	1-10

1. Safety

1.1 Important notes

- This is a product for commercial and industrial use in the "second environment". This is the environment to which all commercial, light manufacturing and industrial enterprises belong, with the exception of those that are connected directly to the low-voltage network for the supply of buildings for residential use.
To prevent disturbances, restrictions regarding the installation or additional measures may be necessary.
- The products listed in the declaration of conformity are not independently operating products in the sense of the EMC directive. The EMC situation cannot be evaluated until the product has been incorporated in a complete system. The evaluation was verified for a typical system configuration, but not for the individual product.
- All technical safety requirements in the product-specific documentation (operating instructions, manual, etc.) must be adhered to throughout the entire product lifecycle.

1.2 Storing the operating instructions

These operating instructions contain safety notices that must be observed during installation and maintenance. Therefore, keep the operating instructions in a safe place for the entire life cycle of the device.

Include the operating instructions if you sell the device or set it up at another location.

1.3 Warning signs

Certain activities can cause danger during operation. Corresponding warning signs concerning the dangers should precede instructions concerning the activities. Danger signs are located on the device.

A warning sign contains signal words which are explained in the following table:

Signal word	Description
DANGER	Indicates a major danger. If it is not avoided, serious injuries or death will result.
WARNING	Indicates a dangerous situation. If it is not avoided, it may lead to serious injuries.

Signal word	Description
CAUTION	Indicates a potentially dangerous situation. If it is not avoided, injuries may occur.
NOTICE	If such a situation is ignored, material damage may result.

Description of the signal words

Tab. 1-1

2. Using the DC-DC module

- Typical fields of application** The DC-DC module is used as a link between a DC link and a DC voltage load or DC voltage source.
The DC voltage source can consist of a battery.
The energy can flow in either direction.
- The DC link voltage must be balanced to earth.
 - Used batteries: All common rechargeable battery systems.
 - The DC-DC module may only be operated in combination with intrinsically safe batteries. The batteries must be connected in accordance with the applicable local standards. The relevant standards are DIN EN 50272-2, IEC62485, IEC61427-1 depending on the type of battery.
 - Maximum permissible voltage: 75 VDC.
- Liability exclusion** Any use not listed under "Typical fields of application" contravenes the intended purpose. TRUMPF is not liable for any ensuing damages, in particular for property damage, personal injury and loss of production. The operator bears all risks. The warranty is rendered null and void.
- Impermissible uses** Impermissible uses include, for example:
- Use of incorrect components.
 - Operation on voltages outside the specification.
 - Operation on DC link voltages which are not balanced to earth.
 - Faulty installation (e.g., cables reversed).
 - Use in unauthorized installation position.
 - Misuse by untrained personnel.
 - Input of wrong parameters.
 - Use in unsuitable environmental conditions:
 - Condensation, icing.
 - Conductive soiling.
 - Corrosive conditions (e.g. battery fumes, salt spray).
 - Voltages outside overvoltage category III (impulse withstand voltage of max. 4 kV).
 - Operation at more than 2000 m above sea level.
 - Operation outdoors.
 - Failure to observe "pollution degree 2" environmental condition.
 - Operation in an explosive environment.
 - Operation with non-intrinsically safe batteries.

3. Authorized personnel

Installation, operation, configuration and maintenance work may only be performed by authorized, trained and instructed personnel.

Authorized persons must be trained and be familiar with the standards and regulations relevant to their tasks.

It is the duty and responsibility of the operator to maintain the qualifications of the authorized personnel. The authorized personnel must therefore be trained at regular intervals.

The following activities may only be performed by authorized persons:

- Setting up the DC-DC module.
- Connecting the DC-DC module.
- Commissioning the DC-DC module.
- Dismantling the DC-DC module.
- Operating the DC-DC module.

4. Warning signs on the DC-DC module

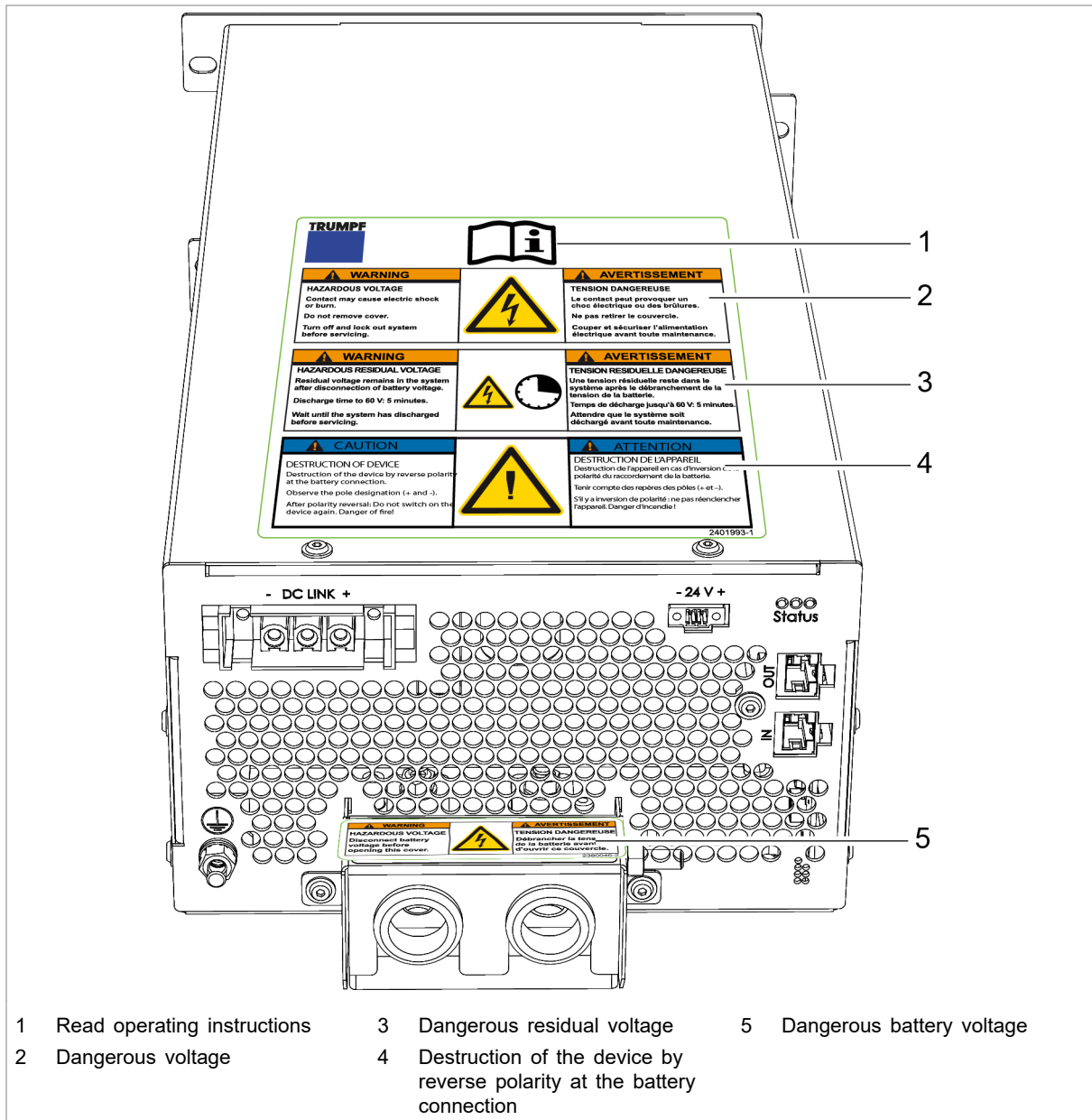

Warning signs on the DC-DC module













Fig. 1-1

5. What you must know as an operator

Note

All warning signs must be present and legible.

If one or more of these warning signs is missing or not legible, contact TRUMPF to request new warning signs.

Warning sign	Meaning			
	This sign indicates that the operating instructions must be read.			
<table border="1" style="width: 100%; border-collapse: collapse;"> <tr> <td style="width: 33%; padding: 2px;"> <p>⚠ WARNING</p> <p>HAZARDOUS VOLTAGE Contact may cause electric shock or burn. Do not remove cover. Turn off and lock out system before servicing.</p> </td> <td style="width: 33%; text-align: center; padding: 2px;">  </td> <td style="width: 33%; padding: 2px;"> <p>⚠ AVERTISSEMENT</p> <p>TENSION DANGEREUSE Le contact peut provoquer un choc électrique ou des brûlures. Ne pas retirer le couvercle. Couper et sécuriser l'alimentation électrique avant toute maintenance.</p> </td> </tr> </table>	<p>⚠ WARNING</p> <p>HAZARDOUS VOLTAGE Contact may cause electric shock or burn. Do not remove cover. Turn off and lock out system before servicing.</p>		<p>⚠ AVERTISSEMENT</p> <p>TENSION DANGEREUSE Le contact peut provoquer un choc électrique ou des brûlures. Ne pas retirer le couvercle. Couper et sécuriser l'alimentation électrique avant toute maintenance.</p>	Sign warns of hazardous voltage.
<p>⚠ WARNING</p> <p>HAZARDOUS VOLTAGE Contact may cause electric shock or burn. Do not remove cover. Turn off and lock out system before servicing.</p>		<p>⚠ AVERTISSEMENT</p> <p>TENSION DANGEREUSE Le contact peut provoquer un choc électrique ou des brûlures. Ne pas retirer le couvercle. Couper et sécuriser l'alimentation électrique avant toute maintenance.</p>		
<table border="1" style="width: 100%; border-collapse: collapse;"> <tr> <td style="width: 33%; padding: 2px;"> <p>⚠ WARNING</p> <p>HAZARDOUS RESIDUAL VOLTAGE Residual voltage remains in the system after disconnection of battery voltage. Discharge time to 60 V: 3 minutes. Wait until the system has discharged before servicing.</p> </td> <td style="width: 33%; text-align: center; padding: 2px;">  </td> <td style="width: 33%; padding: 2px;"> <p>⚠ AVERTISSEMENT</p> <p>TENSION RESIDUELLE DANGEREUSE Une tension résiduelle reste dans le système après le débranchement de la tension de la batterie. Temps de décharge jusqu'à 60 V: 3 minutes. Attendre que le système soit déchargé avant toute maintenance.</p> </td> </tr> </table>	<p>⚠ WARNING</p> <p>HAZARDOUS RESIDUAL VOLTAGE Residual voltage remains in the system after disconnection of battery voltage. Discharge time to 60 V: 3 minutes. Wait until the system has discharged before servicing.</p>		<p>⚠ AVERTISSEMENT</p> <p>TENSION RESIDUELLE DANGEREUSE Une tension résiduelle reste dans le système après le débranchement de la tension de la batterie. Temps de décharge jusqu'à 60 V: 3 minutes. Attendre que le système soit déchargé avant toute maintenance.</p>	Sign warns of hazardous residual voltage.
<p>⚠ WARNING</p> <p>HAZARDOUS RESIDUAL VOLTAGE Residual voltage remains in the system after disconnection of battery voltage. Discharge time to 60 V: 3 minutes. Wait until the system has discharged before servicing.</p>		<p>⚠ AVERTISSEMENT</p> <p>TENSION RESIDUELLE DANGEREUSE Une tension résiduelle reste dans le système après le débranchement de la tension de la batterie. Temps de décharge jusqu'à 60 V: 3 minutes. Attendre que le système soit déchargé avant toute maintenance.</p>		
<table border="1" style="width: 100%; border-collapse: collapse;"> <tr> <td style="width: 33%; padding: 2px;"> <p>⚠ CAUTION</p> <p>DESTRUCTION OF DEVICE Destruction of the device by reverse polarity at the battery connection. Observe the pole designation (+ and -). After polarity reversal: Do not switch on the device again. Danger of fire!</p> </td> <td style="width: 33%; text-align: center; padding: 2px;">  </td> <td style="width: 33%; padding: 2px;"> <p>⚠ ATTENTION</p> <p>DESTRUCTION DE L'APPAREIL Destruction de l'appareil en cas d'inversion de la polarité du raccordement de la batterie. Tenir compte des repères des pôles (+ et -). S'il y a inversion de polarité : ne pas réenclencher l'appareil. Danger d'incendie !</p> </td> </tr> </table>	<p>⚠ CAUTION</p> <p>DESTRUCTION OF DEVICE Destruction of the device by reverse polarity at the battery connection. Observe the pole designation (+ and -). After polarity reversal: Do not switch on the device again. Danger of fire!</p>		<p>⚠ ATTENTION</p> <p>DESTRUCTION DE L'APPAREIL Destruction de l'appareil en cas d'inversion de la polarité du raccordement de la batterie. Tenir compte des repères des pôles (+ et -). S'il y a inversion de polarité : ne pas réenclencher l'appareil. Danger d'incendie !</p>	Sign warns of destruction of the device by reverse polarity at the battery connection.
<p>⚠ CAUTION</p> <p>DESTRUCTION OF DEVICE Destruction of the device by reverse polarity at the battery connection. Observe the pole designation (+ and -). After polarity reversal: Do not switch on the device again. Danger of fire!</p>		<p>⚠ ATTENTION</p> <p>DESTRUCTION DE L'APPAREIL Destruction de l'appareil en cas d'inversion de la polarité du raccordement de la batterie. Tenir compte des repères des pôles (+ et -). S'il y a inversion de polarité : ne pas réenclencher l'appareil. Danger d'incendie !</p>		
<table border="1" style="width: 100%; border-collapse: collapse;"> <tr> <td style="width: 33%; padding: 2px;"> <p>⚠ WARNING</p> <p>HAZARDOUS VOLTAGE Disconnect battery voltage before opening this cover.</p> </td> <td style="width: 33%; text-align: center; padding: 2px;">  </td> <td style="width: 33%; padding: 2px;"> <p>⚠ AVERTISSEMENT</p> <p>TENSION DANGEREUSE Débrancher la tension de la batterie avant d'ouvrir ce couvercle.</p> </td> </tr> </table>	<p>⚠ WARNING</p> <p>HAZARDOUS VOLTAGE Disconnect battery voltage before opening this cover.</p>		<p>⚠ AVERTISSEMENT</p> <p>TENSION DANGEREUSE Débrancher la tension de la batterie avant d'ouvrir ce couvercle.</p>	Sign warns of hazardous voltage on the battery connections.
<p>⚠ WARNING</p> <p>HAZARDOUS VOLTAGE Disconnect battery voltage before opening this cover.</p>		<p>⚠ AVERTISSEMENT</p> <p>TENSION DANGEREUSE Débrancher la tension de la batterie avant d'ouvrir ce couvercle.</p>		

Meaning of the warning signs

Tab. 1-2

6. Dangers from high voltages

 **WARNING**

Life threatening voltage!

The voltages present at the DC-DC module are life-threatening.

- Only have work on the DC-DC module performed by authorized, trained and instructed personnel.
-

The DC-DC module produces voltages that can endanger human life and health. These voltages occur both in the DC-DC module as well as at the outputs of the DC-DC module.

The DC-DC module's connection cables carry voltages that are life-threatening.

A person who comes into contact with live DC-DC module parts may be killed or severely injured.

 **WARNING**

Simultaneous control via web-based user interface and Modbus is possible!

Power transmission stopped using the user interface can be started again and reversed via Modbus.

- Before carrying out work on the device, deenergize all supply lines and secure against reenergizing.
 - Make sure that the device is controlled via one channel only (user interface or Modbus).
-

6.1 Protective measures taken by the manufacturer

The DC-DC module is installed in an enclosed metal casing.

7. What you must know as an operator

7.1 Ensuring safe operation of the DC-DC module

1. The DC-DC module must not be opened.
There are no parts within the DC-DC module that can be serviced by the user.
2. Only operate the DC-DC module within the conditions described in chapter "Technical specifications".
3. For the electrical connection, use only cables that are in perfect condition and have the correct dimensions.

7.2 Check periodically

- Periodically retest acc. to DGUV regulation 3 (DGUV = Deutsche Gesetzliche Unfallversicherung – German Statutory Accident Insurance Association).

Chapter 2

Description

1	Fields of application	2-2
1.1	Typical fields of application	2-2
2	Function description	2-3
2.1	Operation	2-4
3	Construction	2-5
3.1	TruConvert DC series 1000 construction	2-5
3.2	TruConvert System Control construction	2-7
4	Display elements	2-8

1. Fields of application

1.1 Typical fields of application

- Typical fields of application** The DC-DC module is used as a link between a DC link and a DC voltage load or DC voltage source.
The DC voltage source can consist of a battery.
The energy can flow in either direction.
- The DC link voltage must be balanced to earth.
 - Used batteries: All common rechargeable battery systems.
 - The DC-DC module may only be operated in combination with intrinsically safe batteries. The batteries must be connected in accordance with the applicable local standards. The relevant standards are DIN EN 50272-2, IEC62485, IEC61427-1 depending on the type of battery.
 - Maximum permissible voltage: 75 VDC.
- Control** The **TruConvert System Control** external control must be used to monitor and control the DC-DC module.

2. Function description

The DC-DC module is a bidirectional DC voltage converter for charging a battery from a DC link and for feeding energy from a battery back into the DC link.

Voltage limits can be set both for the battery charging and discharging processes as is appropriate for the batteries used.

Note

Instead of a battery, a different DC energy source or DC load can also be used. For the sake of simplicity, we always speak of batteries in these operating instructions.

The device is air-cooled.

- Operation modes**
- The DC-DC module draws energy from a DC link and charges a battery.
 - The DC-DC module draws energy from a battery and feeds it into a DC link.
- Configurations**
- The DC-DC module can be operated as a stand-alone device.
 - Up to 3 DC-DC modules can be connected in parallel on the DC link side (more devices on request) (see "Fig. 2-1", pg. 2-3).
 - Up to 3 DC-DC modules can be connected in parallel on the battery side (see "Fig. 2-2", pg. 2-4).

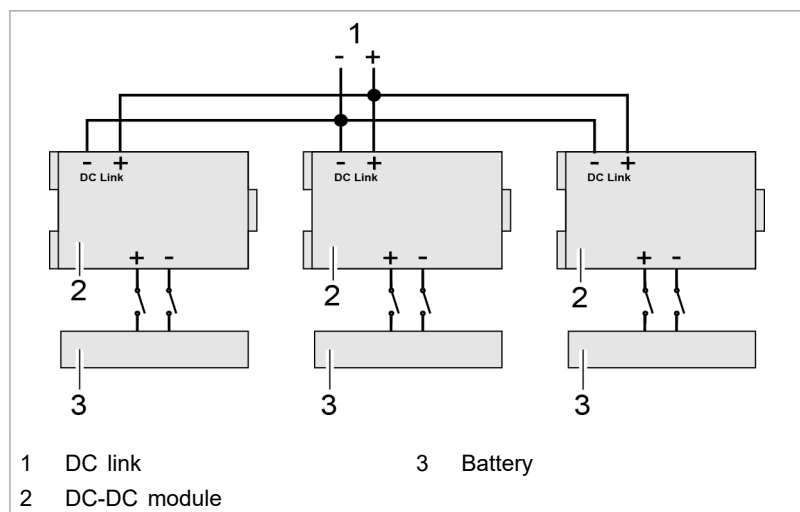

Parallel operation of DC link side

Fig. 2-1

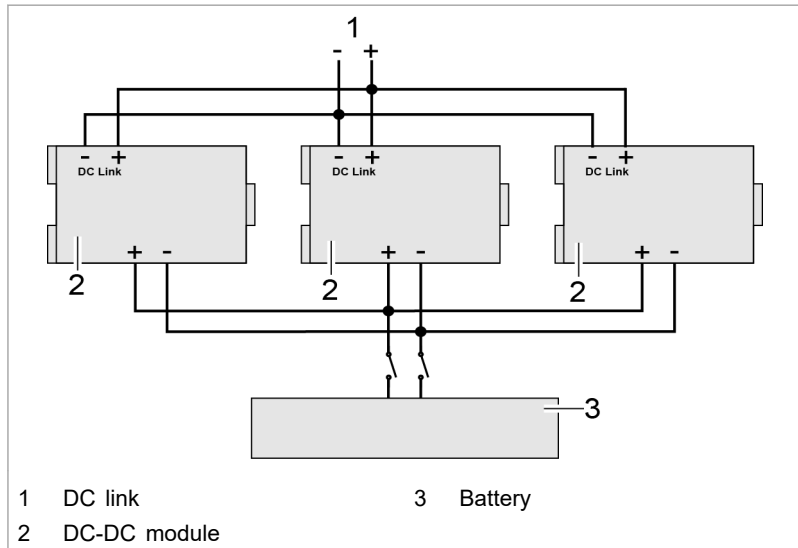

Parallel operation of battery side

Fig. 2-2

2.1 Operation

The DC-DC module can be operated via:

- PC with a web browser
- Modbus TCP/UDP

In both cases, the TruConvert System Control must be connected upstream. In the "DC only" configuration, a TruConvert System Control can control up to 16 DC-DC modules (see "Fig. 2-3", pg. 2-4).

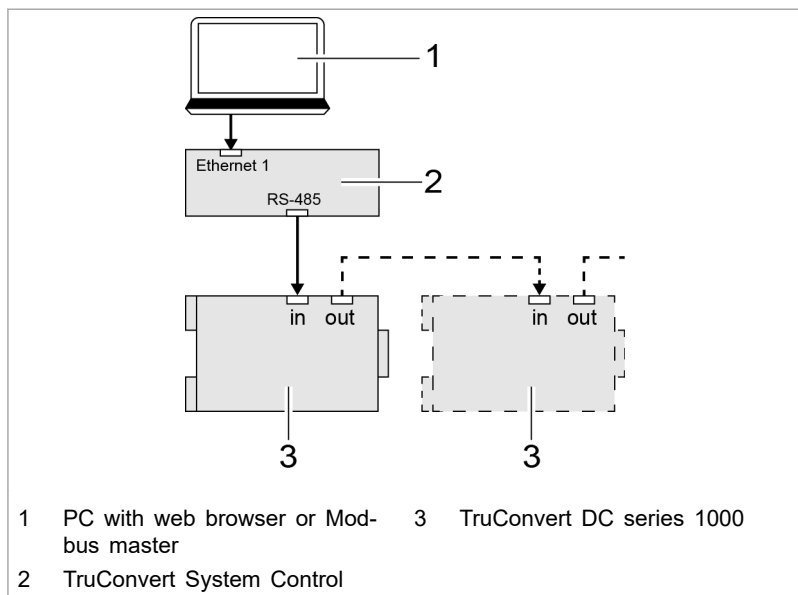

Operation with TruConvert System Control

Fig. 2-3

3. Construction

3.1 TruConvert DC series 1000 construction

Overview The DC-DC module is housed in an enclosed metal housing. The fan on the inside of the front panel draws in air for cooling. All connecting elements are located on the back side.

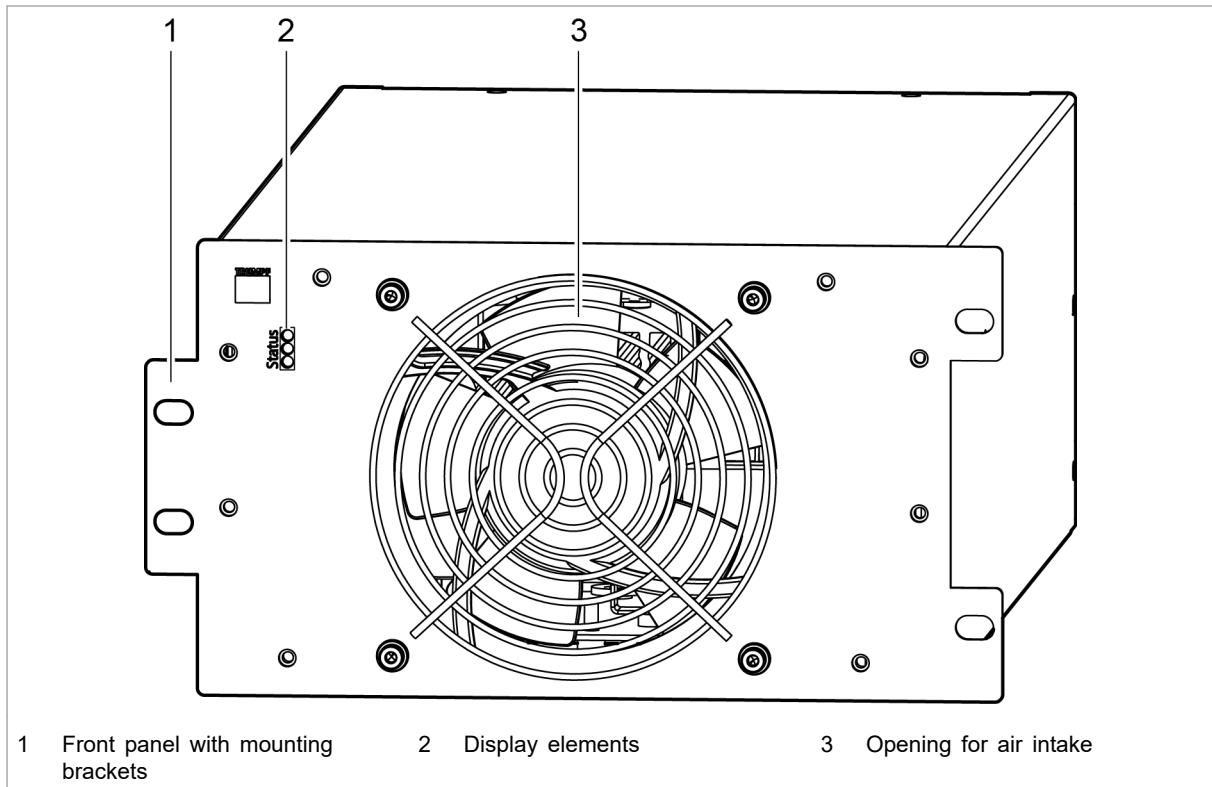

Overview

Fig. 2-4

Rear side

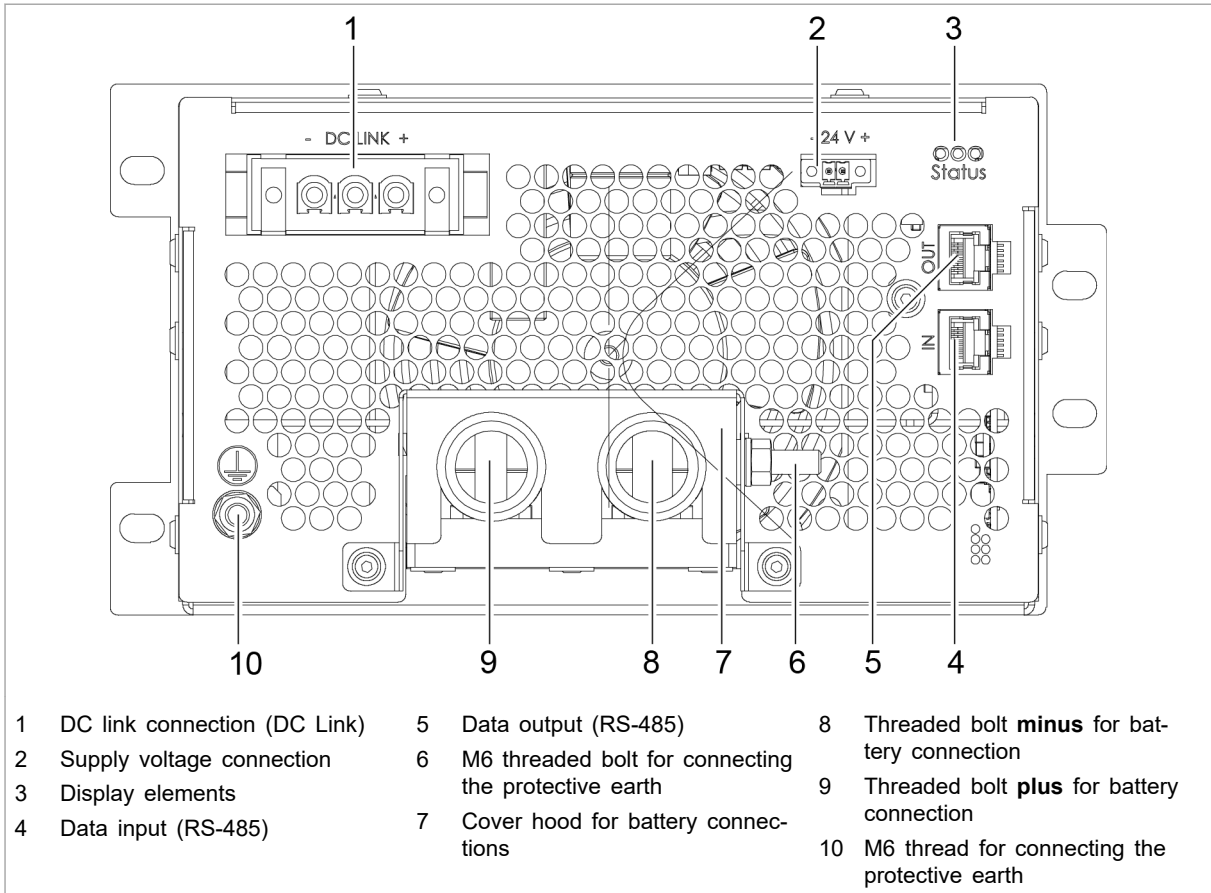

Rear side

Fig. 2-5

3.2 TruConvert System Control construction

Front side

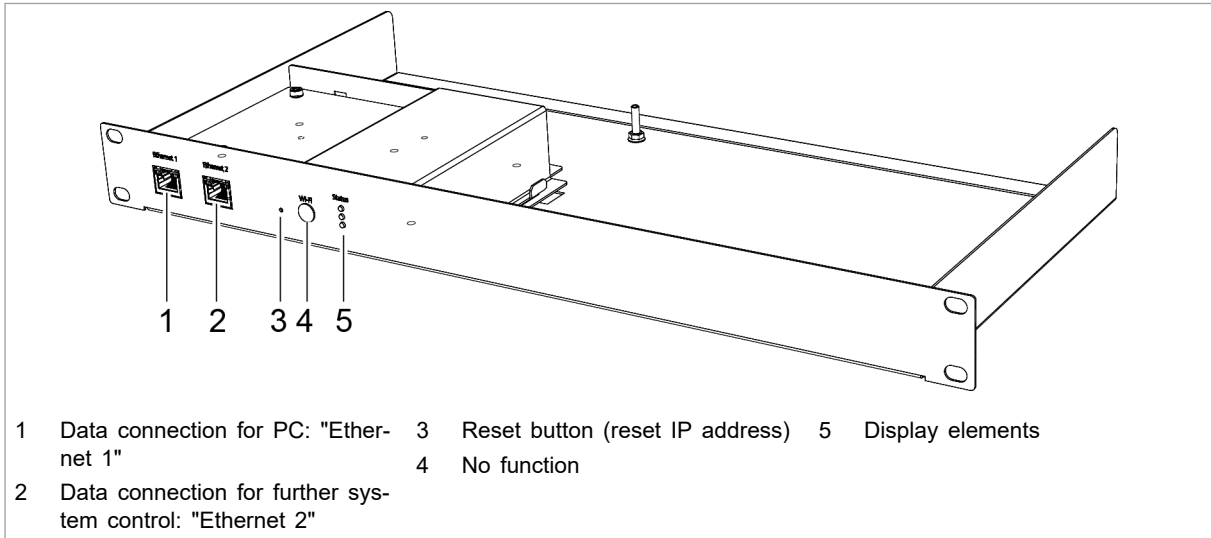

TruConvert System Control front side

Fig. 2-6

Rear side

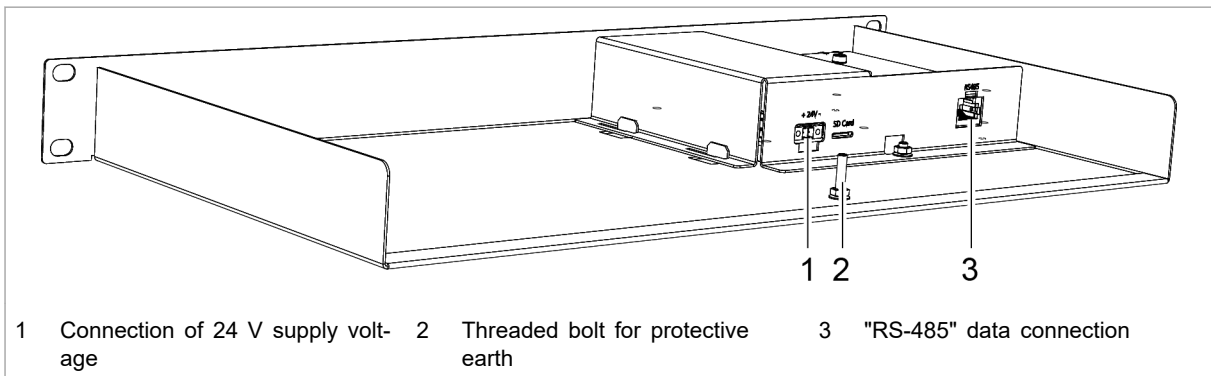

TruConvert System Control rear side

Fig. 2-7

4. Display elements

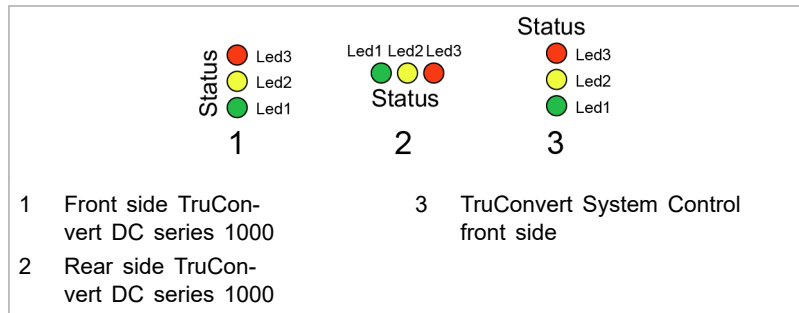

Status LEDs

Fig. 2-8

LED	Device condition				
	Bootloader	Initialize	Alarm	Idling	Operation
LED1 (green)	on	Flashing	off	Flashing	Flashing
LED2 (yellow)	Flashing	Flashing	off	off	Energy direction <ul style="list-style-type: none"> ▪ Battery charging: LED lights up. ▪ Battery discharging: LED flashes.
LED3 (red)	on	Flashing	Flashing	off	off

Status LEDs

Tab. 2-1

Chapter 3

Technical specifications

1	TruConvert DC series 1000 data	3-2
2	TruConvert System Control data	3-8
3	Technical data dependent on device variant (overview)	3-10

1. TruConvert DC series 1000 data

DC link	Description	Value
	DC link voltage	765 VDC to 950 VDC, balanced to earth (maximum 500 V against earth) Deviations possible upon consultation with TRUMPF
	Maximum DC link current	15 ADC
	<p>Fuses:</p> <p>The DC fuses must be provided on-site by the customer.</p> <p>No DC fuses are required for installations with max. 4 TruConvert DC series 1000.</p> <p>The parameters required for dimensioning the fuses depend on the installation situation in the customer system.</p> <p>The following system parameters form the basis for dimensioning:</p> <ul style="list-style-type: none"> ▪ Internal resistances of the sources present in the DC link ▪ Capacitances present in the DC link ▪ Inductivities present in the DC link <p>Taking into account aging and peak current effects yields the following dimensioning of the rated fuse current:</p> $I_{Fuse} = I_{Rated} \times 1.56 = 36 \text{ A} \times 1.56 = 56.16 \text{ A}$ <p>The permissible operating voltage of the fuse must be higher than the DC link voltage.</p> <p>Fuse ratings:</p> $U_{Operation} = 1000 \text{ VDC}$ $I_{Rated} = 63 \text{ ADC}$ <p>Suitable model, e.g.: Littelfuse 0SPF025.T with suitable holders.</p>	

DC link

Tab. 3-1

Battery connection

Description	TruConvert DC	
	1008	1010
Voltage range for charging/discharging	0 V to 75 V DC	
Rated voltage	48 VDC	
Voltage in trickle charging mode	75 VDC	
Nominal current at 0 to 30 V (charging/discharging) ¹ (see "Voltage-current characteristic curve (max. current at U < 30 V)", pg. 3-4)	50 A to 167 A	50 A to 208 A
Nominal current at 30 to 48 V (charging/discharging) ¹	167 A	208 A
Nominal power at voltage up to 48 V charging/discharging ¹	8 kW	10 kW

¹ At ambient temperature of up to 40 °C / 105 °F (TruConvert DC 1008) or 30 °C / 86 °F (TruConvert DC 1010).



Battery connection

Description	TruConvert DC	
	1008	1010
Brief overload while charging/discharging for 10 min ^{1, 2, 3}	10 kW (max. 209 A)	–
Brief overload while charging/discharging for 1 min ^{1, 2, 3}	12 kW (max. 250 A)	–
Reaction time (discharging to charging)	< 10 ms	

Battery connection

Tab. 3-2

Measuring accuracies

Description	Value
Battery voltage	±0.7 V (corresponds to ±1% at 70 V)
Battery current	±3.34 A (corresponds to ±2% at 167 A) Applies for the entire range.
DC link voltage	±15V (corresponds to ±1.5% at 1000 V) Applies for the entire range.

Measuring accuracies

Tab. 3-3

Efficiency

Description	Value
Maximum efficiency	97.4 %
CEC efficiency at 48 V and 800 V (Self-supply not taken into consideration)	96.7 %

Efficiency

Tab. 3-4

Supply voltage

Description	Value
24 V supply voltage	24 VDC ± 10 % / 2 A Note Observe for external fuse: switch-on current is briefly three times the nominal current.

Supply voltage

Tab. 3-5

- 2 Overload operation can reduce the life span of the DC-DC module.
- 3 Applies to devices with material number: 2400760. (For other devices, see chapter 3-3.)

Voltage-current characteristic curve (max. current at U < 30 V)

At a battery voltage < 30 V, the battery current is reduced (charging and discharging).

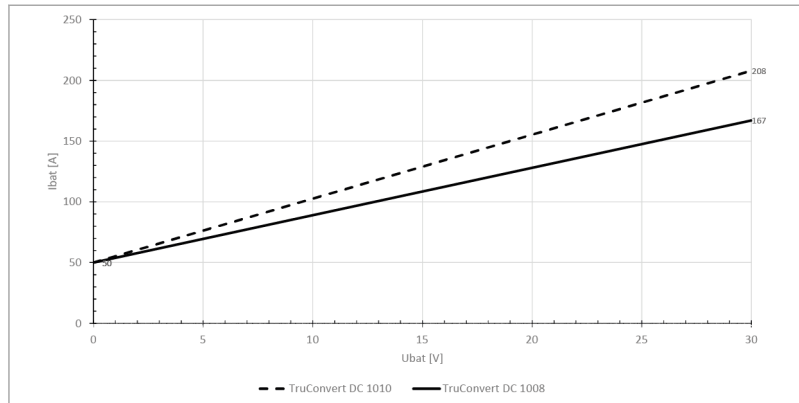

TruConvert DC series 1000: Current-voltage characteristic curve

Fig. 3-1

Temperature-dependent power characteristic curve

At ambient temperatures > 40°C, powers and currents are reduced (charging and discharging).

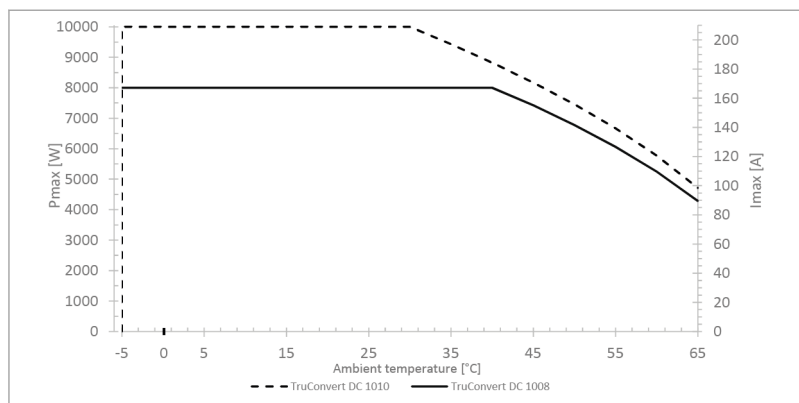

TruConvert DC series 1000: Temperature-dependent power characteristic curve

Fig. 3-2

Life span

Description	Value
Typical life span	> 10 years

Life span

Tab. 3-6

Interfaces

Description	Connection
Battery connection	<ul style="list-style-type: none"> ▪ plus: M8 threaded bolt ▪ minus: M10 threaded bolt
DC link (DC Link)	PCB plug connector, 3-pin IPC 16/ 3-STF-10.16 – 1969467 from Phoenix Contact
24 V supply voltage, DC (24 V)	PCB plug connector, 2-pin MC 1.5/ 2-STF-3.5 – 1847055 from Phoenix Contact
Data input for RS-485 (IN)	RJ-45



Interfaces	Description	Connection
	Data output for RS-485 (OUT)	
Protective earth		<ul style="list-style-type: none"> ▪ M6 internal thread on rear side of housing ▪ M6 threaded bolt on cover hood

Interfaces

Tab. 3-7

Housing	Description	Value
	Dimensions W x H x D (incl. connection components)	
		8.5" x 5.2" x 20.3"
Dimensions W x H x D (without connection components)		216 mm x 132 mm x 456 mm
		8.5" x 5.2" x 18"
Weight		12 kg
Housing material		Galvanized sheet steel
Protection class		IP 20

Housing

Tab. 3-8

Dimensional drawing Dimensional drawing with dimensions for installation:

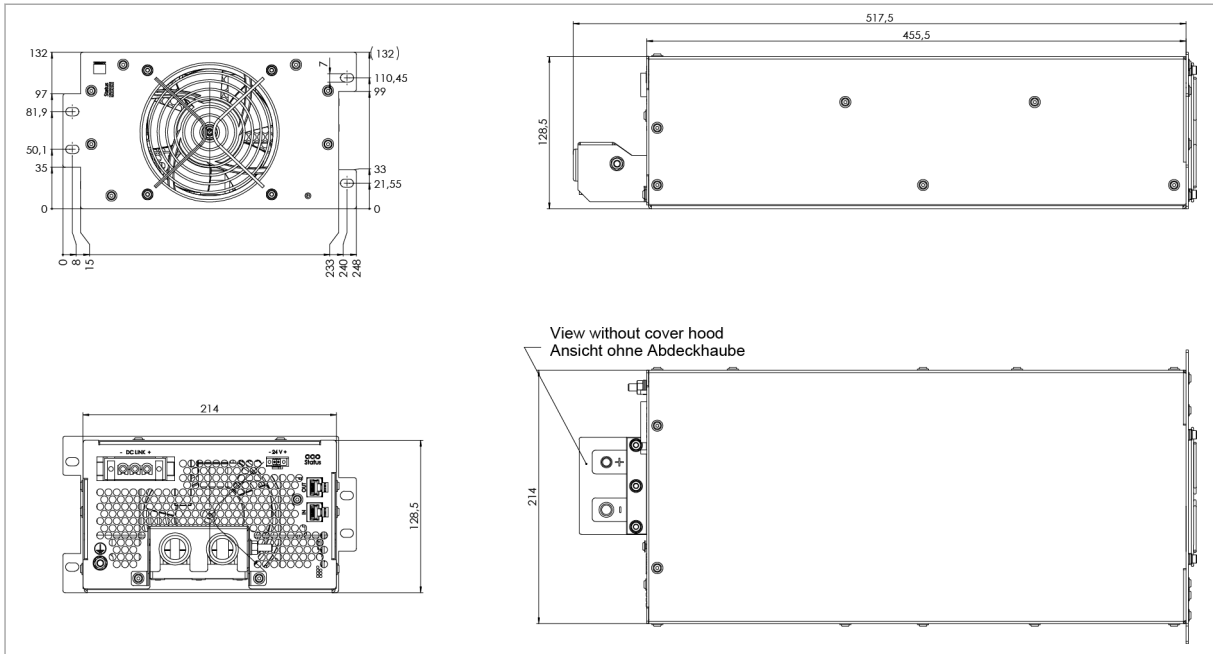

Dimensional drawing

Fig. 3-3

Sound emissions

Description	Value
Sound emission level Distance of 1 m from DC-DC module	< 70 dB(A)

Sound emissions

Tab. 3-9

Environmental conditions

Condition	Temperature	Humidity ⁴	Air pressure	Contamination Micro-environment complies with IEC 62109-1
Rated operation TruConvert DC 1008	-5 °C to +40 °C +23 °F to +104 °F	5 ... 90%	Up to approx. 78 kPa (\pm 2000 m high above sea level)	Pollution degree 2
Rated operation TruConvert DC 1010	-5 °C to +30 °C +23 °F to +86 °F			
Limited power operation TruConvert DC 1008	+40 °C to +65 °C +104 °F to +149 °F			
Limited power operation TruConvert DC 1010	+30 °C to +65 °C +86 °F to +149 °F			
Storage	-20 °C to +80 °C -4 °F to +176 °F	5 ... 90%		
Transport	-20 °C to +80 °C -4 °F to +176 °F	< 90 %		

Environmental conditions

Tab. 3-10

⁴ No condensation or icing

2. TruConvert System Control data

Interfaces	Description	Value
	24 V supply voltage, DC	24 V DC \pm 10 % / 250 mA PCB plug connector, 2-pin
	Ethernet interface 1	<ul style="list-style-type: none"> ▪ Connection for web-based user interface or Modbus TCP/UDP ▪ RJ-45
	RS-485 interface	<ul style="list-style-type: none"> ▪ Connection for TruConvert AC 3025 or TruConvert DC series 1000 ▪ RJ-45
	Reset button	Resetting the IP address
	Display	3 status LEDs

TruConvert System Control interfaces

Tab. 3-11

Housing	Description	Value
	Dimensions W x H x D	Approx. 435 mm x 44.5 mm x 253 mm Approx. 17.13" x 1.75" x 10"
	Dimensions of front panel	Approx. 482 mm x 44.5 mm Approx. 19" x 1.75"

Housing

Tab. 3-12

Dimensional drawing

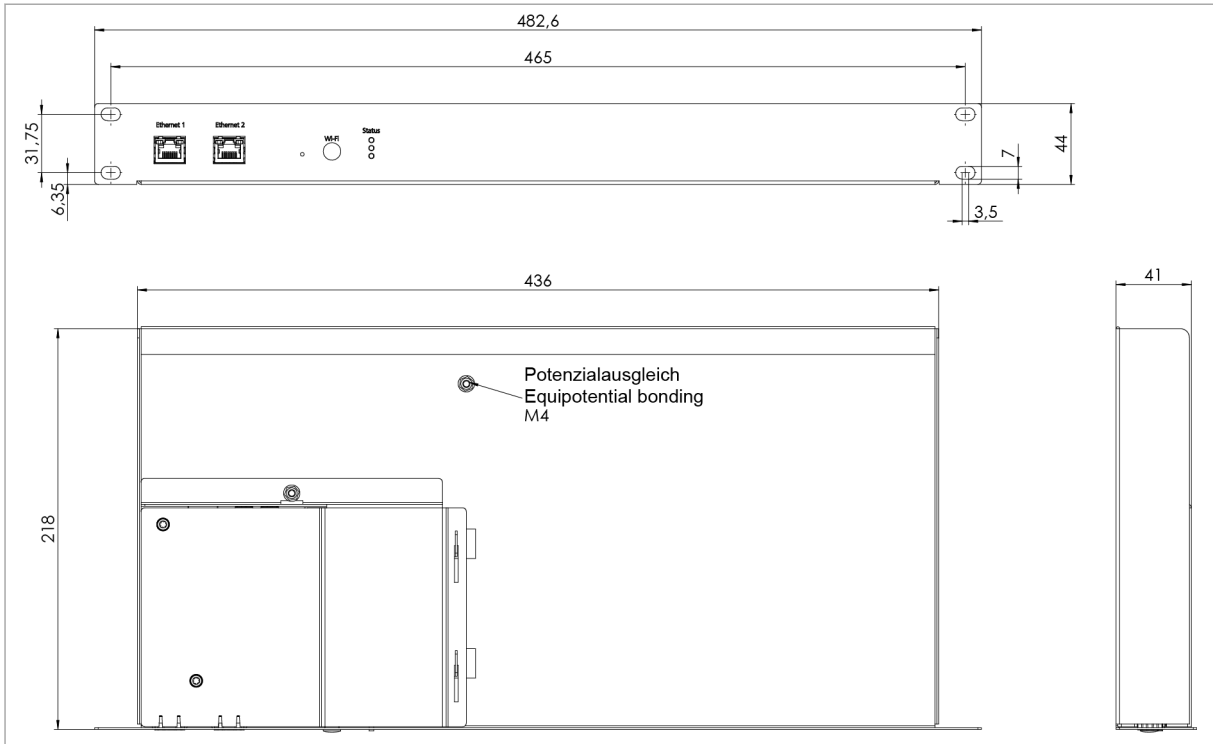

Dimensional drawing

Fig. 3-4

Environmental conditions

Condition	Temperature	Humidity ⁵	Air pressure	Contamination Micro-environment complies with IEC 62109-1
Operation	-5 °C to +65 °C 23 °F to +149 °C	5 ... 90 %	Up to approx. 78 kPa (≙ 2000 m high above sea level)	Pollution degree 2
Storage	-20 °C to +80 °C -4 °F to +176 °F	5 ... 90 %		
Transport	-20 °C to +80 °C -4 °F to +176 °F	< 90 %		

Environmental conditions

Tab. 3-13

5 No condensation or icing

Description	Value
Brief overload while charging/discharging for 10 min ^{1, 2}	–
Brief overload while charging/discharging for 1 min ^{1, 2}	–

Battery connection: maximum values

Tab. 3-15

Chapter 4

Interfaces

1	Protective earth	4-2
2	Supply voltage 24 V DC	4-4
3	DC link	4-5
4	Battery connection	4-6
5	RS-485 data input/data output (IN/OUT)	4-7
6	Interfaces on the system control	4-8
6.1	24 V supply voltage (DC)	4-8
6.2	Ethernet	4-8
6.3	RS-485	4-9

1. Protective earth

Note

For the protective earth connection on the TruConvert DC series 1000, there is a thread on the rear side of the housing and a threaded bolt on the cover hood.

To ensure safe operation, **both** protective earth connections must be connected to the earthing system with **2 separate** PE conductors.

View

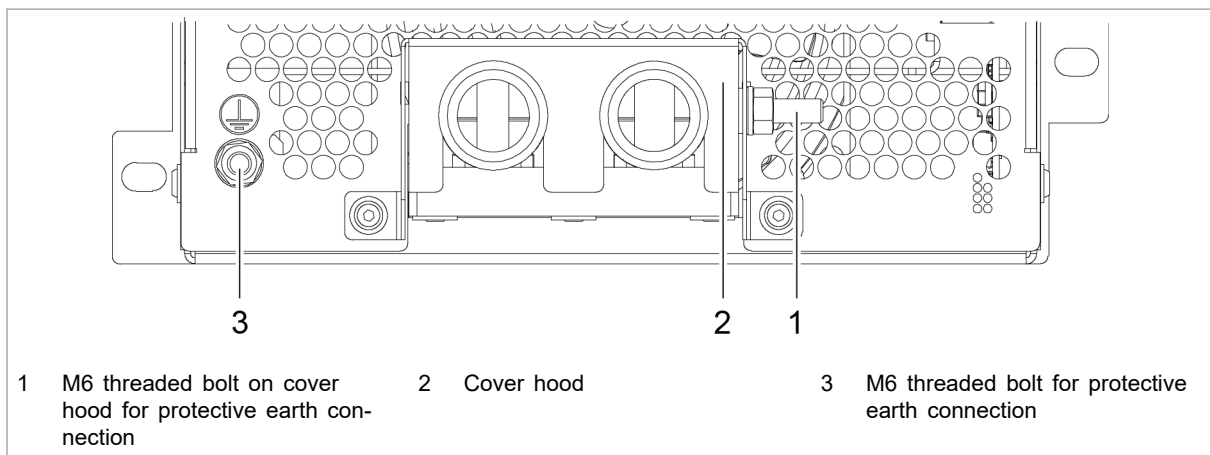

Protective earth connections

Fig. 4-1

- Connection**
- On the rear side of the housing: M6 internal thread
 - On the cover hood: M6 threaded bolt

Cable requirement The cross section of the protective earth is dependent on the **grounding concept** of the overall system.

- Grounding concept 1: battery cables ungrounded**
- 1 x 4 mm² / 1 x AWG 10

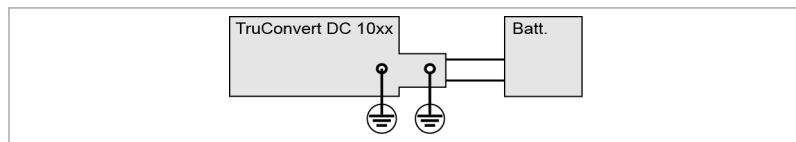

Fig. 4-2

- Grounding concept 2: battery cables grounded on one end**
- The cross section of the protective earth must be calculated by the system manufacturer according to the battery properties and fuse properties.

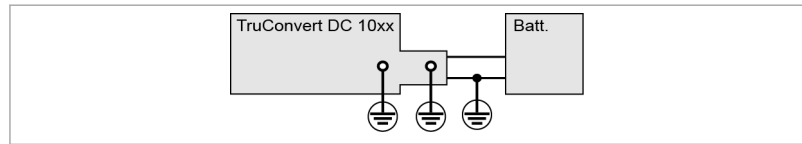

Fig. 4-3

2. Supply voltage 24 V DC

Note

The negative terminal of the supply voltage is **not** connected to GND in the DC-DC module. The grounding must be performed by the customer.

View

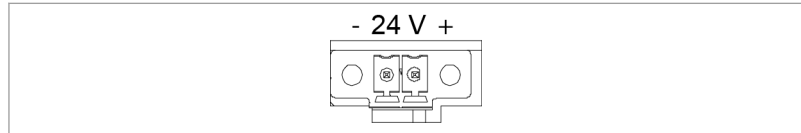

Supply voltage 24 V DC

Fig. 4-4

Connection

- At the DC-DC module: Phoenix PCB plug connector
- Required counterpart: connector, 2-pin, 8A, CS 3,5 mm

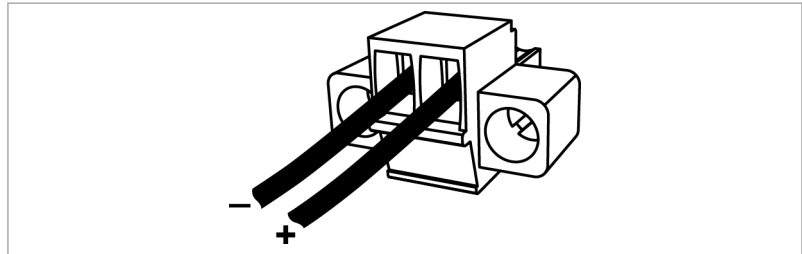

Connector for 24 V DC

Fig. 4-5

Fuse

External fuse protection must be provided by the customer.

3. DC link

View

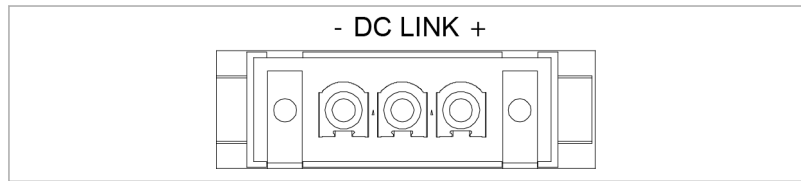

DC link

Fig. 4-6

- Connection**
- At the DC-DC module: Phoenix PCB plug connector
 - Required counterpart: connector, 3-pin, 76A, CS 10,16 mm

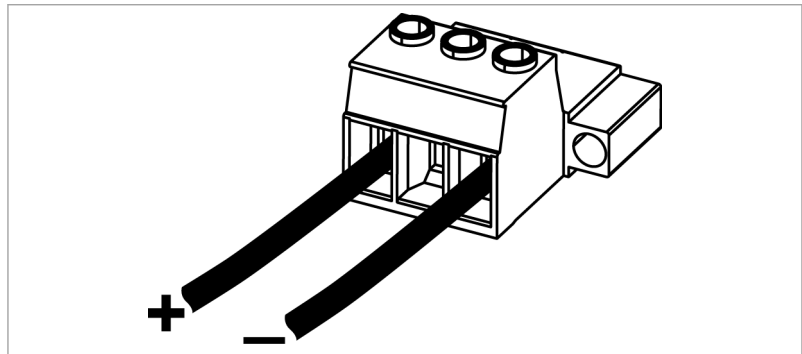

Connector for DC link voltage

Fig. 4-7

- Cable requirement**
- 2 x 2.5 mm² / 2 x AWG 13
 - The insulation must exhibit sufficient electric strength.

Note

To keep inductivity at a minimum cables should be twisted.

External fuse protection All-pole, max. 20 A.

4. Battery connection

View

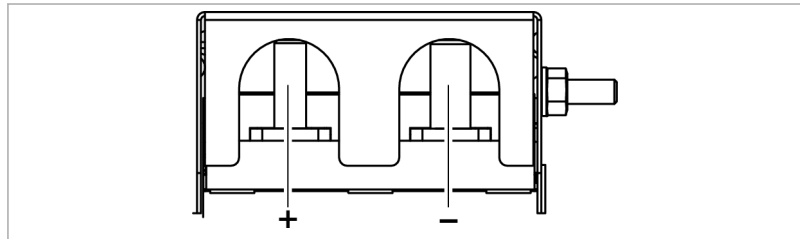

Battery connection

Fig. 4-8

- Connection**
- **Plus:** M8 threaded bolt.
 - **Minus:** M10 threaded bolt.

Required connection components:

- Cable lugs made of ETP copper.

- Cable requirement**
- Select min. cross section according to local regulations.
 - Max. inductivity: 7.5 μH .
 - Max. length: < 5 m.

Note

To keep inductivity at a minimum cables should be twisted.

External fuse protection All-pole, max. 350 A.

Separators The customer must install suitable separation devices into the connection between the DC-DC module and battery.
The separation devices must comply with applicable standards.

- Connection types**
- Individual connection.
 - Parallel connection (up to 3 DC-DC modules).

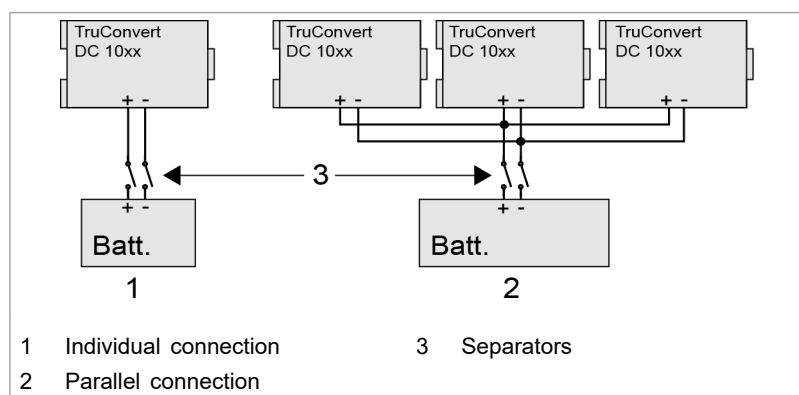

Connection types for the batteries

Fig. 4-9

5. RS-485 data input/data output (IN/OUT)

View

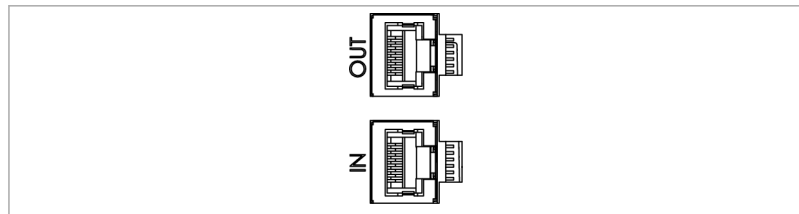

Data connections IN/OUT

Fig. 4-10

Connection ■ RJ-45 male connector

Cable requirement ■ Twisted pair patch cable in accordance with standard TIA/EIA-568A/B
 ■ CAT 5 or higher
 ■ Max. length: 30 m

Note

The total length of the data cable must not exceed 30 m from the PC to the last system control.

6. Interfaces on the system control

TruConvert System Control These interfaces are located on the system control TruConvert System Control.

6.1 24 V supply voltage (DC)

Note

The negative terminal of the supply voltage is **not** connected to PE in the TruConvert System Control. Grounding must be performed by the customer, as close to the housing as possible.

View

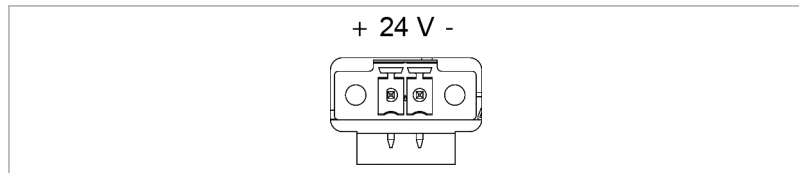

24 V supply voltage (DC)

Fig. 4-11

Connection

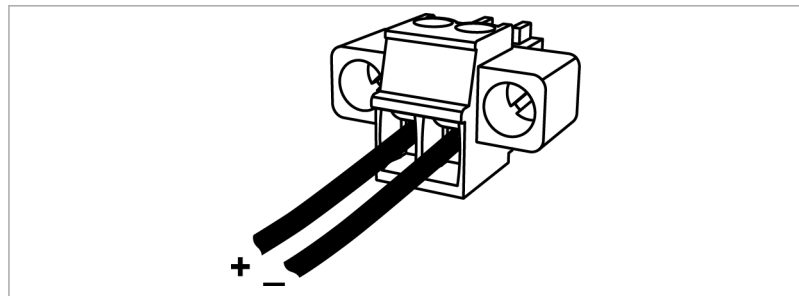

Connector for 24 V supply voltage (DC)

Fig. 4-12

- On the device: Phoenix PCB plug connector
- Required counterpart: connector, 2-pin, 8A, CS 3.5 mm

Fuse External fuse protection must be provided by the customer.

6.2 Ethernet

View

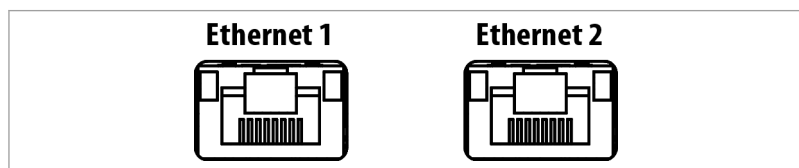

Ethernet data connection

Fig. 4-13

Connection ■ RJ-45 male connector

Cable requirement ■ Twisted pair patch cable in accordance with standard TIA/EIA-568A/B

- CAT 5 or higher
- Max. length: 100 m

6.3 RS-485

View

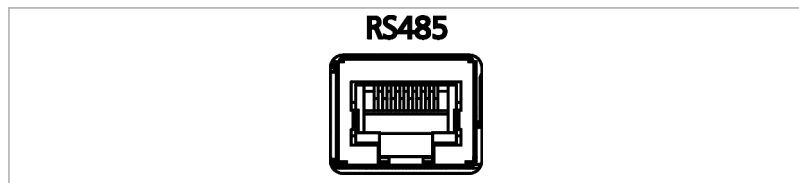

RS-485 data connection

Fig. 4-14

Connection ■ RJ-45 male connector

Cable requirement ■ Twisted pair patch cable in accordance with standard TIA/EIA-568A/B

- CAT 5 or higher
- Max. length: 30 m

Note

The total length of the data cable must not exceed 30 m from the PC to the last system control.



Chapter 5

Standards and directives

1	CE certification	5-2
2	EU declaration of conformity TruConvert DC 1008 / TruConvert DC 1010	5-3
3	EU declaration of conformity TruConvert System Control	5-4
4	CSA certification	5-5
4.1	Location of the CSA mark	5-5

1. CE certification

EU directives:

- Low-voltage directive 2014/35/EU
- Electromagnetic compatibility directive 2014/30/EU

Standards taken into account:

- EN 62040-2: 2006/AC: 2006
- EN 62109-1:2010
- UL 1741
- IEC 62109-2
- IEC 62477-1

2. EU declaration of conformity TruConvert DC 1008 / TruConvert DC 1010

Class C1 is achieved when the supply lines of the 24 V supply voltage are equipped with the provided ferrite cores. Otherwise class C2 is achieved.

TRUMPF



EU Declaration of Conformity

in accordance with
Low Voltage Directive 2014/35/EU
Directive relating to electromagnetic compatibility 2014/30/EU

We hereby declare that the following device complies with all the relevant requirements of the EU directives listed above.

Device:	TruConvert DC 1008 TruConvert DC 1010
Serial number:	≥ 205019125
Applied harmonized standards, in particular:	EN 62109-1:2010, EN 62040-2:2006 / AC Klasse C1
Party authorized to compile the technical file:	Benedikt Röser

Town / Date / Signature Freiburg im Breisgau, 16.09.2020

Benedikt Röser
Quality Director

TRUMPF Hüttinger GmbH + Co. KG
Bötzingen Straße 80
79111 Freiburg im Breisgau, Germany

Phone +49 (0) 761 8971-0
Fax +49 (0) 761 8971-1150

Info.Elektronik@de.trumpf.com
www.trumpf.com

TE172sc
V 2019 - 11

en

EU declaration of conformity TruConvert DC 1000 series (material numbers: 2400760 / 2582407)

Fig. 5-1

3. EU declaration of conformity TruConvert System Control

Class C1 is achieved when the supply lines of the 24 V supply voltage are equipped with the provided ferrite cores. Otherwise class C2 is achieved.

TRUMPF



EU Declaration of Conformity

in accordance with
Low Voltage Directive 2014/35/EU
Directive relating to electromagnetic compatibility 2014/30/EU

We hereby declare that the following device complies with all the relevant requirements of the EU directives listed above.

Device:	TruConvert System Control
Serial number:	≥ 203622306
Applied harmonized standards, in particular:	EN 62109-1:2010, EN 62040-2:2006 / AC Klasse C1
Party authorized to compile the technical file:	Benedikt Röser

Town / Date / Signature

Freiburg im Breisgau, 10.02.2020

Benedikt Röser
Quality Director

TRUMPF Hüttinger GmbH + Co. KG
Bötzinger Straße 80
79111 Freiburg im Breisgau, Germany

Phone +49 (0) 761 8971-0
Fax +49 (0) 761 8971-1150

Info.Elektronik@de.trumpf.com
www.trumpf.com

TE172sc
V 2019 - 11

en

4. CSA certification

System control and DC-DC module that bear the CSA mark are certified by CSA (see "Location of the CSA mark", pg. 5-5).

Standards taken into account:

- CSA C22.2 No. 107.1-16
- UL 1741 Second Edition
- IEC62109-1 First Edition
- National Differences UL62109-1
 - IEC 62109-1:2010
 - EN 62109-1:2010

4.1 Location of the CSA mark

If the name plate of the device bears the CSA mark, this device was certified by CSA.

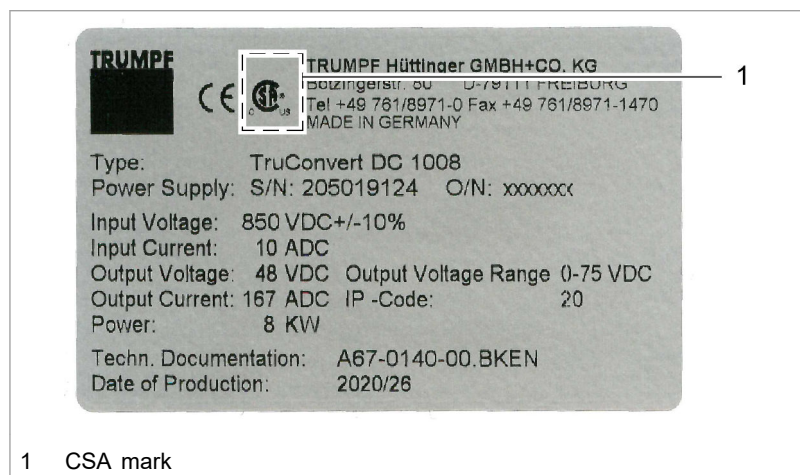

Location of the CSA mark on the name plate

Fig. 5-3

Chapter 6

Installation

1	After receiving the module	6-3
1.1	Inspecting the delivery	6-3
2	Unpacking	6-4
2.1	Disposing of packaging material	6-4
3	Transport, storage	6-5
3.1	Transport	6-5
3.2	Storage conditions	6-5
4	Requirements for the site	6-6
5	Possible installation positions	6-7

6	Electrical connection	6-8
6.1	Establishing electrical connection	6-8
6.2	Connection diagram with 3 DC-DC modules (example)	6-11
7	Dismantling	6-13
7.1	Dismantling the DC-DC module	6-13
8	Shipping	6-14
8.1	Shipping the module	6-14
9	Disposal	6-15
9.1	Disposing of the module	6-15

1. After receiving the module

1.1 Inspecting the delivery

1. Check the device immediately as soon as it is delivered for completeness in accordance with the delivery note and also for visible damages incurred during transport.
2. In order to retain the right of recourse, report any shipping damages immediately in writing to the forwarding agent, the insurance company and TRUMPF.

2. Unpacking

2.1 Disposing of packaging material

If you do not want to keep the packaging material for a subsequent transport:

- Dispose of all packaging materials in compliance with the relevant regional waste disposal regulations.

3. Transport, storage

3.1 Transport

1. Transport DC-DC-module in the original packaging.
If the original packaging is no longer available:
Suitable packaging material can be purchased from TRUMPF.
2. Maintain specified environmental conditions.

3.2 Storage conditions

If you do not install the module immediately following delivery:

1. Store the module in original packaging.
If the original packaging is no longer available:
Suitable packaging can be purchased from TRUMPF.
2. Maintain specified environmental conditions.

4. Requirements for the site

- Installation indoors**
- Operation is permissible in a closed electrical operating room only.
 - According to IEC 62477-1, installation, mounting and operation are only permissible in:
 - Non-flammable environment.
 - Indoors with air conditioning.

Air intake and air outlet Sufficient space must be present for air intake and air outlet.

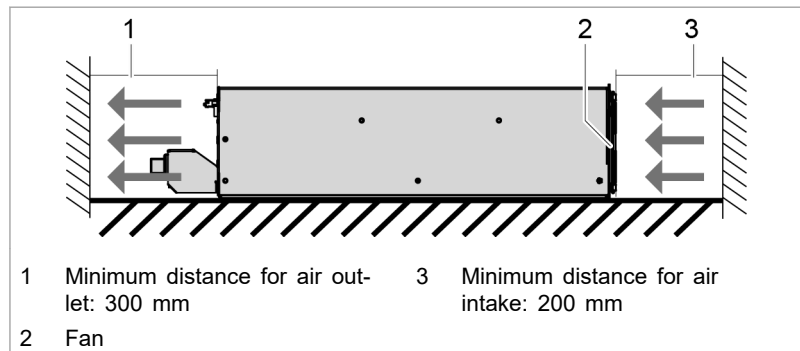

Air circulation intervals

Fig. 6-1

Maximum back pressure Sufficient cooling of the module is only ensured if a sufficient air flow rate up to a maximum permissible back pressure is provided.

In addition, note that the air flow rate must be multiplied by the number of devices if several modules are operated.

Air short circuits and mutual interference of the modules must be prevented.

Number of modules	Air flow rate	Maximum back pressure in the air duct
1	200 m ³ /h	20 Pa
n	n x 200 m ³ /h	20 Pa

Maximum back pressure

Tab. 6-1

Mains separation device Access to the external mains separation device must not be obstructed by the device.

Fuses Fuses must be provided on-site by the customer .

5. Possible installation positions

Horizontal position

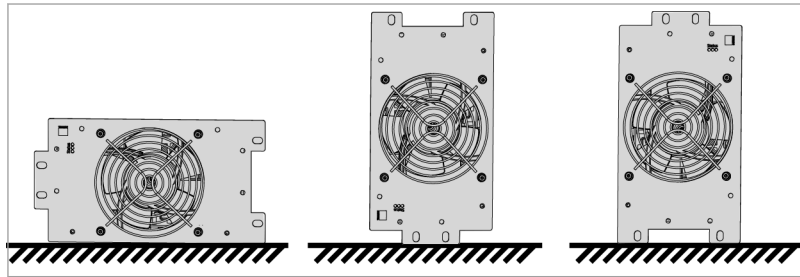

Possible orientations in horizontal position

Fig. 6-2

Operation in a horizontal position is permitted without restrictions.

Vertical position

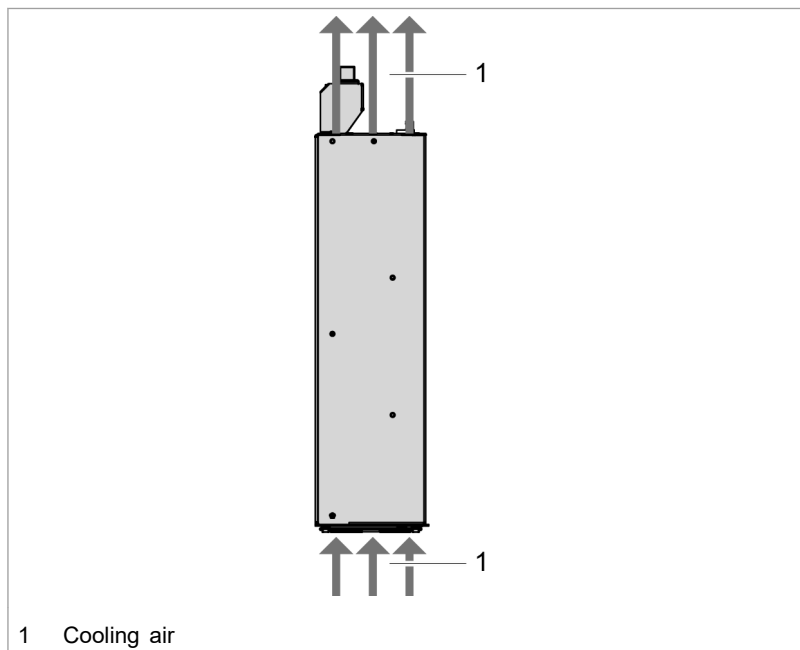

Possible orientation in vertical position

Fig. 6-3

Operation in a vertical position is only permitted under the following conditions:

- The cooling air moves in the upwards direction.
- Installation of a collection tray under the DC-DC module.
The collection tray must prevent any glowing parts from the device from dripping onto a flammable base. The collection tray therefore fulfils the function of a fire protection housing.

6. Electrical connection

Note

All installation work must comply with the specifications of the Authority Having Jurisdiction (AHJ).

DANGER

Connection cables carry life-threatening voltage.

- Do not work under voltage.
- Before connecting, check battery cables to ensure that they are not electrically live.
- Before connecting, check DC link voltage cables to ensure that they are not electrically live.

DANGER

Danger of fire

- Observe the installation regulations of the installation site.
- Fuse the battery connection with max. 350 ADC at all poles.
- Fuse the DC link with max. 20 ADC at all poles.

NOTICE

Destruction of the device by reverse polarity at the battery connection.

- Observe the pole designation (+ and -).
- After polarity reversal: Do **not** switch on the device again. Danger of fire!

NOTICE

Abrupt connection of the DC link voltage can destroy DC-DC modules.

- Slowly increase the DC link voltage of 0 V to maximum voltage (ramp > 1 s).

NOTICE

Abrupt connection of the battery voltage can destroy the DC-DC module.

- Pre-charge battery connection parts of the DC-DC module to current battery voltage.

6.1 Establishing electrical connection

Condition

- Battery is fully discharged for all connection work.

or

- If it is not possible to fully discharge the battery, appropriate separators are to be installed in the connection between DC-DC module and battery.
- The separation devices must comply with applicable standards.
- Before closing the separators, the battery connections must be pre-charged to the current battery voltage!

Means, Tools, Materials

- Terminating resistor for the data output (provided).
- Ferrite core for 24 V supply cable (provided).
- If necessary, pre-charger for pre-charging the battery connections on the DC-DC module to battery voltage.

Connecting protective earth to DC-DC module

Note

To ensure safe operation, **both** protective earth connections must be connected to the earthing system with **2 separate** PE conductors.

1. Screw protective earth to the internal thread of the housing back panel. Max. torque: 8 Nm.
2. Screw protective earth to the threaded bolt on the cover hood. Max. torque: 8 Nm.

Connecting protective earth to system control

3. Screw protective earth on TruConvert System Control. Max. torque: 2 Nm.

Connecting the battery

4. Fully discharge the battery and ensure absence of voltage.

or

- If the battery cannot be discharged: open separators on the battery.
5. Remove the cover for the battery connection on the DC-DC module.
 6. Ensure that the end sleeves of the battery cables are insulated with suitable shrink tubing.

NOTICE

Destruction of the device by reverse polarity at the battery connection.

- Observe the pole designation (+ and -).
- After polarity reversal: Do **not** switch on the device again. Danger of fire!

7. Connect the battery cables. Observe polarity. Max. torque: 25 Nm.

8. Screw the cover for battery connections back on. Max. torque: 2 Nm.
9. When working with charged battery, also perform the following steps:
 - Ensure that the separator is open.
 - Pre-charge battery connections to current battery voltage with suitable pre-charger.
 - Close separator.

Connecting DC link

 **DANGER**

Connection cables carry life-threatening voltage.

- Do not work under voltage.
 - Before connecting, check DC link voltage cables to ensure that they are not electrically live.
-

10. Connect DC link voltage cables to the "DC Link" interface.

or

- During parallel operation of several DC-DC modules: Connect "DC Link" interfaces of the DC-DC modules in parallel and connect DC link voltage cables.

Connecting data cable

11. Connect data connection "RS-485" of the TruConvert System Control with data input "IN" of the DC-DC module.
12. Connect the terminating resistor to the "OUT" data output of the DC-DC module.

or

- If several DC-DC modules are connected in parallel: Connect the "OUT" data output of the DC-DC module to the "IN" data input of the next DC-DC module.

Connect the terminating resistor to the "OUT" data output of the last DC-DC module.

13. Connect the TruConvert System Control to the master (Modbus master or PC with web browser)

Connect 24 V supply voltage

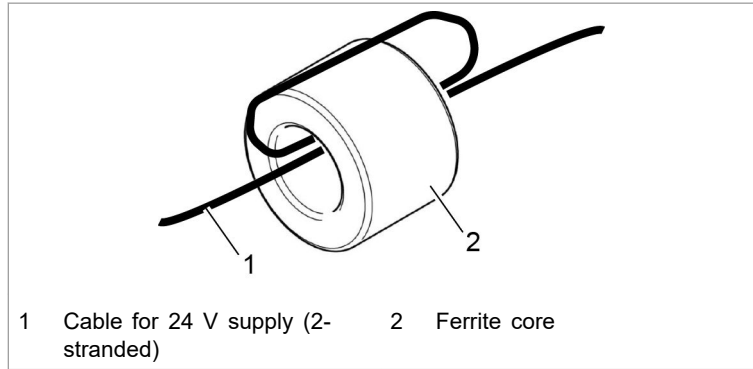

Ferrite core

Fig. 6-4

14. To satisfy EMC requirement C1, equip the cables for the 24 V supply of the DC-DC module and the system control with the provided ferrite cores:

- Wrap the cable once around the ferrite core.
- Position the ferrite core as closely as possible to the male connector.

15. Connect supply voltage 24 VDC to the DC-DC module.

16. Connect the 24 VDC supply voltage to the TruConvert System Control.

LED1 (green) flashes and shows that the DC-DC module is operational (see "Display elements", pg. 2-8).

6.2 Connection diagram with 3 DC-DC modules (example)

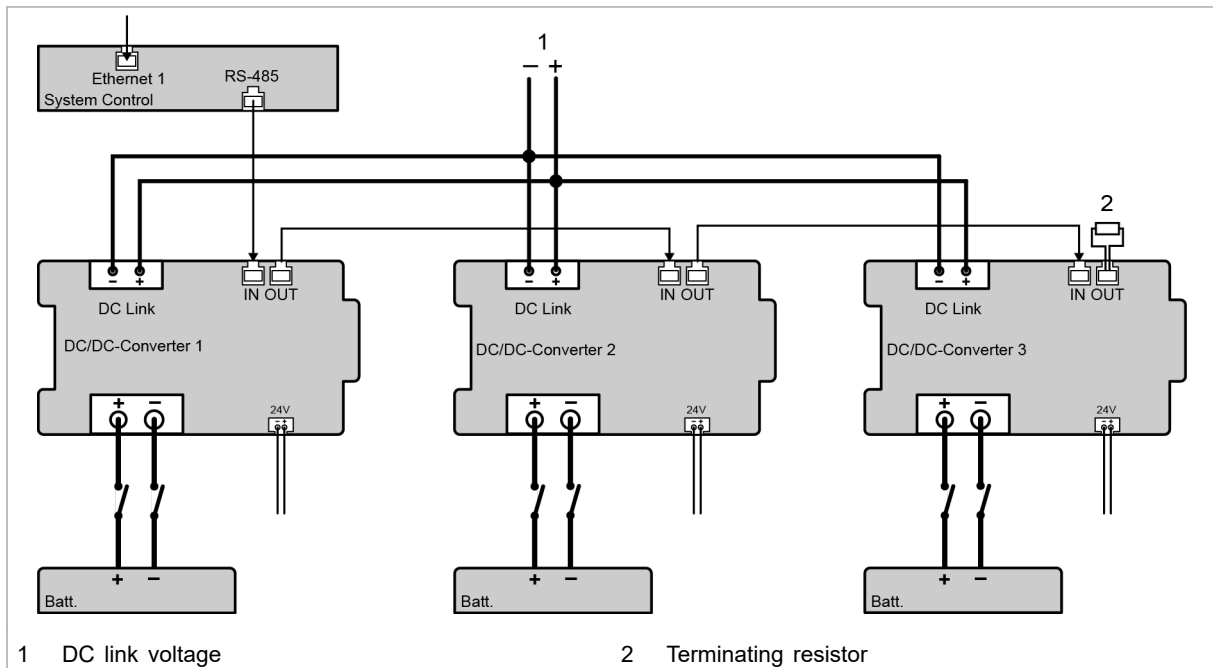

Connection diagram: example with 3 DC-DC modules

Fig. 6-5

Note

The terminating resistor **must** be connected to the last bus participant to ensure data transmission.

The terminating resistor must be connected even if there is only one bus participant.

Use only the **provided terminating resistor**.

7. Dismantling

7.1 Dismantling the DC-DC module

 **WARNING**

Connection cables carry life threatening voltage!

- Fully discharge battery.
 - If the battery cannot be discharged: open separators on the battery.
 - Disconnect the connection cables to the DC link voltage.
 - Maintain discharging time.
-

Removing residual voltages

1. Fully discharge battery.
or
 - If the battery cannot be discharged: open separators on the battery.
2. De-energize the connection cables to the DC link voltage.
3. De-energize the connection cables to the 24 V supply voltage.

Unscrew or unplug cables

4. Unscrew connection cables to the battery on the DC-DC module.
5. Unplug connection cables for the DC link voltage on the DC-DC module.
6. Unplug supply voltage 24 V DC.
7. Unplug data cable.
8. Unscrew protective earth.

8. Shipping

8.1 Shipping the module

- Use packaging material which can withstand transport stresses to ship the module.

If the original packaging is no longer available:
Suitable packaging material can be purchased from TRUMPF.

9. Disposal

9.1 Disposing of the module

- Observe the local regulations when disposing of the module.

Chapter 7

Operation

1	Commissioning	7-3
1.1	Performing initial commissioning	7-3
2	Operation via web-based user interface	7-9
2.1	Calling up the web GUI	7-9
2.2	Menu structure	7-10
3	Operation via Modbus	7-11
3.1	Establishing a connection	7-11
3.2	Modbus Register Map	7-11
4	Transmission of power	7-16
4.1	Switching the transmission of power on/off	7-16

5	Displaying and resetting messages	7-18
5.1	User interface: displaying and resetting messages	7-18
5.2	Modbus: displaying and resetting messages	7-20
6	Overload	7-22
6.1	Operating with overload	7-22
6.2	Examples: Reduce and then again increase overload capacity	7-23
7	Actual values	7-24
7.1	Display actual values	7-24
8	Process set values	7-26
8.1	Set process set values	7-26
9	Data backup	7-28
9.1	Saving data	7-28
10	System configuration	7-29
10.1	Setting the system configuration	7-29
11	System control	7-32
11.1	Setting the system time	7-32
11.2	Changing network settings	7-32
12	Software update	7-34
12.1	Perform software update	7-34
13	Device information	7-35
13.1	Displaying device information	7-35
14	Favorites	7-36
14.1	Creating a favorites page	7-36
15	Search	7-37
15.1	Searching	7-37
16	State diagram	7-38

1. Commissioning

1.1 Performing initial commissioning

Conditions

- PC on which one of the following browsers is installed:
 - Microsoft Internet Explorer from version 11.
 - Microsoft Edge.
 - Google Chrome from version 46.
 - Firefox from version 40.
- Ethernet cable for connecting PC and TruConvert System Control.

The initial commissioning of the device is only possible via the web GUI.

Establishing and testing the connection

1. Set the same IP Subnet Mask on the PC as on the TruConvert System Control.
IP Subnet Mask of the TruConvert System Control on delivery: 255.255.255.0
2. Set the same address range on the PC as on the TruConvert System Control:
192.168.1.-
3. On the PC, set the last block of the IP address.
Do not set the same address as on the TruConvert System Control!
IP address of the TruConvert System Control on delivery: 192.168.1.2
Do not set 0!
4. Connect PC and TruConvert System Control with Ethernet cable.
5. To switch on the system control and the modules: switch on the 24 V supply voltage.
All 3 status LEDs blink to display the "Initialization" state.
6. Open the web browser on the PC.
7. Enter IP address of the TruConvert System Control in the address line.
IP address of the TruConvert System Control on delivery: 192.168.1.2

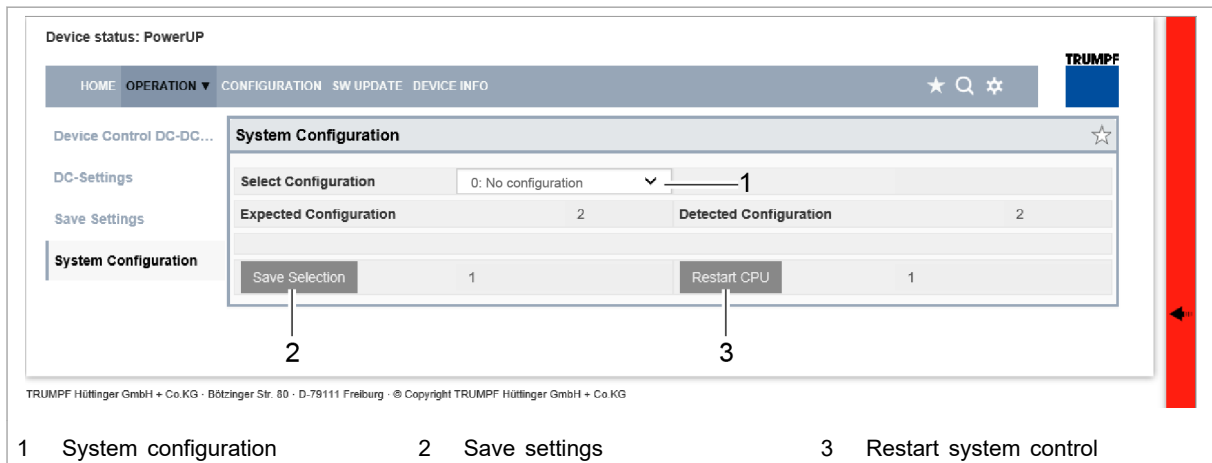

Initial commissioning display

Fig. 7-1

The browser displays the user interface of the TruConvert System Control and the connected modules.

Several system controls are used in one system?

- Connect one system control after another to the PC and change the default IP address to a unique IP address.

Set configuration

8. Select >Operation >System Configuration.
9. In "Select Configuration", select the present system configuration:
 - 0: No configuration
This configuration only occurs in the event of an error, e.g., if there is no connection to the modules (check cables) or if an incorrect module type was detected (check alarm messages).
 - 1: Simulator
The system control alone is used and connected modules are simulated.
 - 2: DC-DC only
Only DC-DC modules are connected to the system control.
 - 3: n (AC-DC + m DC-DC)
AC/DC and DC/DC modules are connected to the system control.
10. To save the selection: press "Save Selection".
11. To restart the TruConvert System Control: press "Restart CPU".

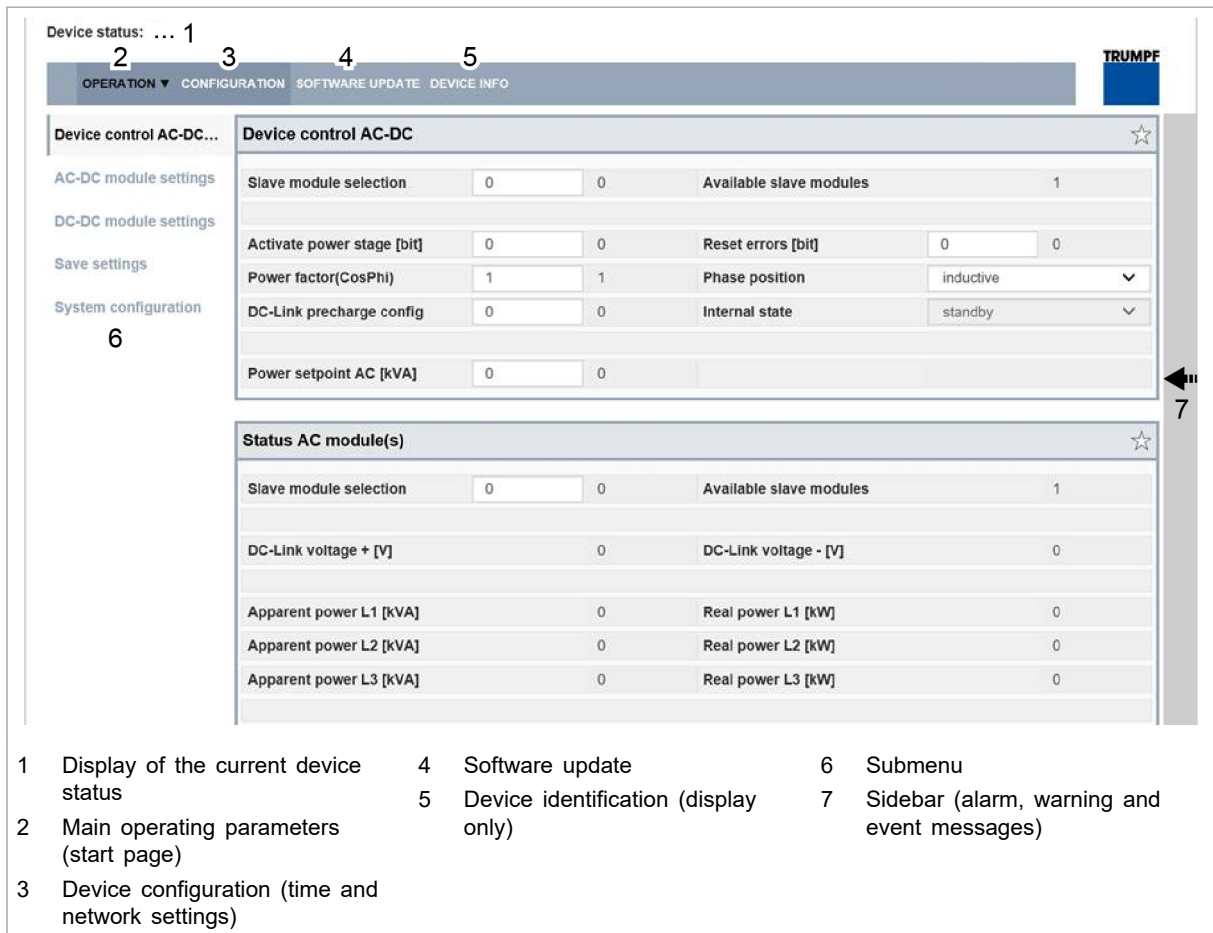

Start screen

Fig. 7-2

The system control balances the set system configuration with the actually connected modules. If both values match, the start screen of the web GUI is displayed.

If the set system configuration ("Expected Configuration") differs from the automatically detected system configuration ("Detected Configuration"), the initial commissioning screen is displayed again and a message output. Press sidebar (7) to display the messages.

Setting process set values (DC settings)

- 12. Select >Operation >DC Settings.
- 13. Every input in the following steps must be confirmed with the enter key ↵.

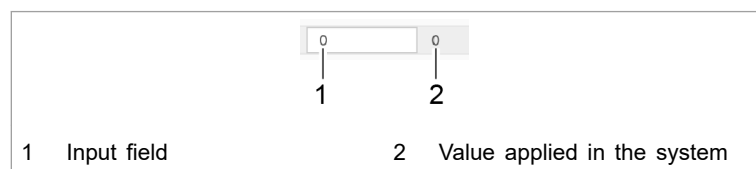

Confirm input

Fig. 7-3

The value applied in the system is then displayed to the right next to the input field.

- 14. Either

- To set the set values for a single DC-DC module: Enter the number of the slave in the "Slave Module Selection" area under "Slave Number".

The number of available DC-DC modules is displayed in "Available Slave Modules".

The DC-DC module, which is directly connected to the system control with the data cable, is "Slave Number" = 1. The next DC-DC module, which is connected to data output "OUT" of slave 1, is "Slave Number" = 2. The DC-DC module connected to this is "Slave Number" = 3 etc.

or

- To uniformly set the set values for all DC-DC modules: set the "Slave Number" = 0.
15. For "DC Voltage Limits", enter:
 - "Minimum Battery Voltage [V]": lower limit, up to which the battery is discharged.
Upon reaching the limit value, the discharging current is reduced.
 - "Maximum Battery Voltage [V]": upper limit, up to which the battery is charged.
Upon reaching the limit value, the charging current is reduced.
 16. Enter the limit values for the DC-DC module in the "DC Voltage Alarm Thresholds" area:
 - "Minimum Battery Voltage Threshold [V]": lower limit, up to which the battery is discharged.
If this value is not met (e.g., due to short circuit of the battery), the TruConvert System Control generates an alarm message.
 - "Maximum Battery Voltage Threshold [V]": upper limit, up to which the battery is charged.
If the value is exceeded, the TruConvert System Control generates an alarm message.
 - Select the values so that they lie outside of the "DC Voltage Limits" control range.
The difference between Minimum Battery Voltage [V] and Minimum Battery Voltage Threshold [V] should be 5 V. A smaller difference is possible as well but may result in shutdowns.
 17. Enter limit values for the charging and discharging current in the "DC Current Settings" area:
 - "Maximum Battery Charge Current [A]": maximum battery charging current.
 - "Maximum Battery Discharge Current [A]": maximum battery discharging current
 18. Enter limit value for the power output/power draw in the "DC Power Settings" area:
 - "Maximum Terminal Power [W]": maximum power.

19. Enter current-voltage characteristic curve in the "Voltage Current Characteristics (VCC) Settings" area (see "Fig. 3-1", pg. 3-4):

- "VCC Start Point Current [A]": battery current at minimum battery voltage.
- "VCC End Point Current [A]": battery current upon reaching "VCC End Point Voltage [V]".
- "VCC End Point Voltage [V]": battery voltage.

The charging and discharging current of a battery are set as a function of the voltage with the "VCC Settings". The values must be selected so that they lie in the shaded part of the VCC curve.

The dashed line shows the "VCC Settings" on delivery (default values).

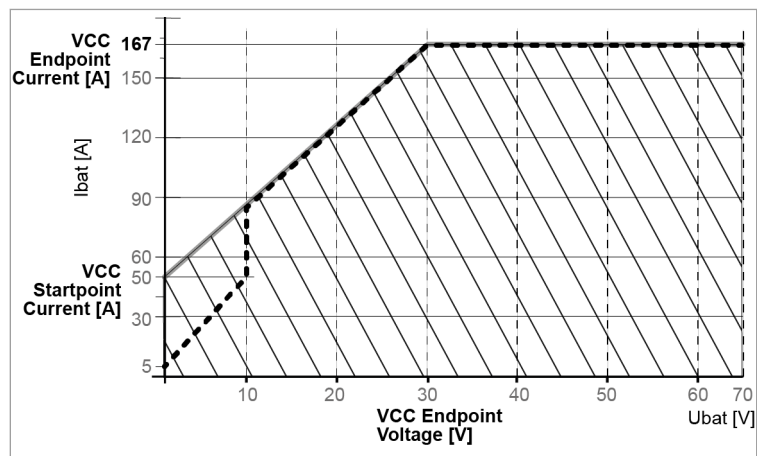

VCC curve

Fig. 7-4

Start transmission of power

20. Check the device status in the upper left corner of the user interface:

- "Device status: Idle": Idle: The device is ready for use.
- "Device status: Error, Power Up": Error: The device is not ready for use. An alarm message is pending (see "Displaying and resetting messages", pg. 7-18).

or

- Check status LED 1 on the DC-DC module:
 - LED flashes green: The device is ready for use.
 - LED flashes red: The device is not ready for use. An alarm message is pending (see "Displaying and resetting messages", pg. 7-18).

21. Select >Operation >Device control DC-DC.

22. Either

- To set the set values for a single DC-DC module: Enter the number of the slave in the "Device control DC-DC" area under "Slave module selection".

The number of available DC-DC modules is displayed in "Available slave modules".

or

- To uniformly set the set values for all DC-DC modules: set the "Slave number" = 0.
23. Set the following in the "Device control DC-DC" area:
- "Set value battery current [A]": battery current set value in A.
Charge battery: enter negative value (-250 to 0).
Discharge battery: enter positive value (0 to +250).
 - "Battery current slope [A/ms]": maximum allowed battery current change in A/ms (default value = 100 A/ms).
24. To start the transmission of power:
- For "Activate power stage [bit]", enter = "1".
 - Press key ↓.

The status changes from "Idle" to "Operation".

The status LEDs on the AC-DC module and system control light up orange. The contactor connects the mains.

Stop transmission of power

25. To stop the transmission of power:
- For "Activate power stage [bit]", enter = "0".
 - Press key ↓.

The status changes from "Operation" to "Idle".

The status LEDs on the AC-DC module and system control light up green. The contactor disconnects the mains.

The initial commissioning is completed.

The device can now continue to be operated via the web GUI or via Modbus.

Tip

The Modbus register provides an overview of the set default values (see ["Modbus Register Map"](#), pg. 7-11).

2. Operation via web-based user interface

2.1 Calling up the web GUI

Condition

- Initial commissioning was performed (see "Commissioning", pg. 7-3).

- To switch on the TruConvert System Control and the connected modules: switch on the 24 V supply voltage.
- Open the web browser on the PC.
- Enter IP address of the TruConvert System Control in the address line.

IP address of the TruConvert System Control on delivery:
192.168.1.2

1 Display of the current device status

2 Main operating parameters (start page)

3 Device configuration (time and network settings)

4 Software update

5 Device identification (display only)

6 Submenu

7 Sidebar (alarm, warning and event messages)

Start screen

Fig. 7-5

The browser displays the user interface of the TruConvert System Control and the connected modules.

- Every value entered in the user interface must be confirmed with enter key ↵.

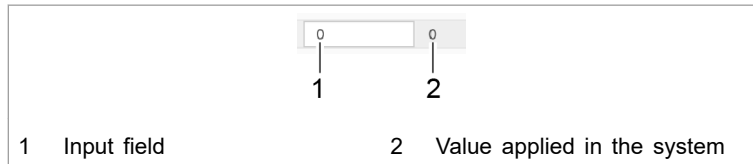

Confirm input

Fig. 7-6

The value applied in the system is then displayed to the right next to the input field.

2.2 Menu structure

Main menu	Submenu	Description
>HOME	—	Start screen (see "Calling up the web GUI", pg. 7-9)
>OPERATION	>Device control DC-DC	(see "Switching the transmission of power on/off", pg. 7-16) (see "Display actual values", pg. 7-24)
	>DC-DC module settings	(see "Operating with overload", pg. 7-22) (see "Set process set values", pg. 7-26)
	>Save settings	(see "Saving data", pg. 7-28)
	>System configuration	(see "Setting the system configuration", pg. 7-29)
>CONFIGURATION	—	Base settings for the TruConvert System Control: (see "Setting the system time", pg. 7-32) (see "Changing network settings", pg. 7-32)
>SOFTWARE UPDATE	—	(see "Perform software update", pg. 7-34)
>DEVICE INFO	—	Information on device identification

Menu structure of the web-based user interface

Tab. 7-1

3. Operation via Modbus

Protocol: TCP/UDP.

Differences for Modbus – user interface

Note

Operation via Modbus is the standard method of operation for regular operation.

Configuration, initial commissioning and software update of the TruConvert System Control and the connected modules can be performed via the user interface.

Function	User interface	Modbus
Operation	x	x
System configuration	x	x
Software update	x	—
Changing the IP address	x	—
Data backup	x	—

Differences in operation

Tab. 7-2

3.1 Establishing a connection

Condition

- Initial commissioning was performed (see "[Commissioning](#)", pg. 7-3).
1. Connect the TruConvert System Control to the Modbus master with an Ethernet cable.
 2. To switch on the system control and the modules: switch on the 24 V supply voltage.

The PCS (Power Conversion System) is ready for communication via Modbus.

3.2 Modbus Register Map

- Base settings: address range 1000 to 1999
- Info system: address range 2000 to 2399
- Alarm and warning messages: address range 2400 to 3999
- Process set values: address range 4000 to 4999
- Process actual values: address range 5000 to 5999

Base settings

Addr	Description	Unit	Resolution	Default	Min	Max	Dat. type	Type	Length	FCr	FCw
1000	Date	dd.mm.yyyy					UINT32	Register	2	03	16
1002	Time	hh:mm:ss					UINT32	Register	2	03	16
1004	IP Address	xxx.xxx.xxx.xxx		0xC0A80102	1	0xFFFFFFF	UINT32	Register	2	04	
1006	Subnet	xxx.xxx.xxx.xxx		0xFFFFFFFF0	1	0xFFFFFFF	UINT32	Register	2	03	16
1008	Gateway	xxx.xxx.xxx.xxx		0xC0A80101	1	0xFFFFFFF	UINT32	Register	2	03	16
1010	Reset parameters to factory settings	bit		0	0	1	UINT16	Coil	1	01	05
1016	Timeout for communication	s	1.0	10	1		UINT16	Register	1	03	06
1017	Setting this flag will restart the CPU (only in Idle or Error State)	-		0	0	1	UINT16	Coil	1	01	05
1018	Setting for connected system configuration	-		0	0	4	UINT16	Register	1	03	06
1028				0	-1	1	INT16	Register	1	03	06

Base settings

Tab. 7-3

Info area

Addr.	Length	Data type	F-Code read	F-Code write	Description	Unit	Resolution
2000	2 reg.	UINT32	04	—	Serial number TruConvert System Control	String	—
2002	2 reg.	UINT32	03	—	Serial number TruConvert DC 1008	String	—

Info area

Tab. 7-4

Alarm and warning messages

Addr	Description	Unit	Resolu-tion	Default	Min	Max	Dat. type	Typ e	Len gth	FCr	FCw
2402	Count of pending warn-ings	Coun t					UIN T16	Regi ster	1	04	
2403 to 2422	Warning Code of Alarm 1 to 20						UIN T16	Regi ster	1	04	
2808	Alarms have changed	bit			0	1	UIN T16	Coil	1	01	
2809	Count of pending alarms	Coun t					UIN T16	Regi ster	1	04	
2810 to 2829	Error Code of Alarm 1 to 20						UIN T16	Regi ster	1	04	
3215	Events have changed	bit			0	1	UIN T16	Coil	1	01	
3216	Actual events	Coun t					UIN T16	Regi ster	1	04	
3217 to 3236	Events 1-100						UIN T16	Regi ster	1	04	

Alarm and warning messages

Tab. 7-5

Process set values

Addr.	Len gth	Data type	F.-Code read	F.-Code write	Description	Unit	Reso-lution	Defaul t	Min / max
4000	1 coil	UINT 16	01	05	Power operation <ul style="list-style-type: none"> ▪ 0 = No power operation (DC-DC module not active) ▪ 1 = Power operation active 	—	—	0	0/1
4002	1 coil	UINT 16	01	05	Reset <ul style="list-style-type: none"> ▪ 1 = Reset all error messages 	—	—	0	0/1
4007	1 reg.	UINT 16	03	06	Number of the slave to be addressed	—	—	0	0/16
4008	1 reg.	UINT 16	03	06	Error behavior during operation with multiple slaves <ul style="list-style-type: none"> ▪ 0 = Entire system continues to run if an error occurs at an individual participant ▪ 1 = Entire system is switched off if an error occurs at an individual participant 	—	—	0	0/1

Addr.	Length	Data type	F-Code read	F-Code write	Description	Unit	Resolution	Default	Min / max
4100	1 reg.	UINT 16	03	06	Max. battery voltage	V	0.01	4800	0/7000
4101	1 reg.	UINT 16	03	06	Min. battery voltage	V	0.01	0	0/7000
4106	1 reg.	UINT 16	03	06	Max. battery charging current	A	0.1	1670	0/2500
4109	1 reg.	UINT 16	03	06	Max. battery discharging current	A	0.1	1670	0/2500
4112	1 reg.	UINT 16	03	06	End voltage of the voltage-current characteristic curve	V	0.1	100	100/700
4115	1 reg.	UINT 16	03	06	Maximum voltage of the voltage-current characteristic curve	A	1.0	50	5/167
4118	1 reg.	UINT 16	03	06	Initial voltage of the voltage-current characteristic curve	A	1.0	5	1/50
4121	1 reg.	UINT 16	03	06	Max. power per DC phase	W	1.0	8000	0/12000
4124	1 reg.	UINT 16	03	06	Max. battery voltage / alarm limit	V	0.1	750	0/750
4127	1 reg.	UINT 16	03	06	Min. battery voltage / alarm limit	V	0.1	0	0/700
4500	1 reg.	INT 16	03	06	Battery current set value in pure DC-DC operation	A	1.0	0	-250/250
4501	1 reg.	UINT 16	03	06	Permitted current change dynamic in pure DC-DC operation	A/ms	0.01	10000	1/35000

Process set values

Tab. 7-6

Process actual values

Addr.	Length	Data type	Function code read	Description	Unit	Resolution	min/max
5000	1 reg.	INT16	04	Current status (see "State diagram", pg. 7-38) <ul style="list-style-type: none"> ▪ 0 = Switching on ▪ 1 = Alarm ▪ 2 = Idling ▪ 3 = Operation ▪ 4 = Maintenance 	—	1.0	-2/10
5001	1 reg.	UINT16	04	Number of connected slaves	—	—	—
5010	5 reg.	STRING	04	Current operating mode	String	—	—
5100	1 reg.	UINT16	04	Battery voltage	V	0.1	0/1200
5110	1 reg.	INT16	04	Battery current	A	1	—
5120	1 reg.	INT16	04	DC power	kW	0.001	—

Addr.	Length	Data type	Function code read	Description	Unit	Resolution	min/max
5123	1 reg.	UINT16	04	Status of current limiting <ul style="list-style-type: none"> ▪ 0 = Not active ▪ 1 = Pmax ▪ 2 = Max. charging current ▪ 4 = Max. discharging current ▪ 8 = Max. battery voltage ▪ 16 = Min. battery voltage (multi-mode display possible) 	—	1	—
5126	1 reg.		04	Overload capacity	%	0.1	
5127	1 reg.		04	DC link voltage	V	1.0	
5300	32 reg.	STRING	03	Status of the limiting controller for battery voltage (not active)	String	—	—
5510	1 reg.	INT16	04	Suction air temperature	°C	1.0	

Process actual values

Tab. 7-7

4. Transmission of power

4.1 Switching the transmission of power on/off

Conditions

- Initial commissioning was performed (see "Commissioning", pg. 7-3).
- Operation via web-based user interface or Modbus.

Enter process set values

1. Selection of a DC-DC module (only relevant if multiple modules are connected to a TruConvert System Control).
 - User interface:
Select *>Operation >Device Control DC-DC*.
Select a module in the "Device Control DC-DC" area for "Slave Module Selection".
 - Modbus:
Enter the number of the slave to be addressed (see "Tab. 7-6", pg. 7-14).

Note

User interface and Modbus have different scaling.

For example:

100 A/ms = 100 on user interface = 10000 in Modbus.

2. Enter set value for the battery current in A.

Charge battery: enter negative value.

Discharge battery: enter positive value.

- User interface:
Under "Set Value Battery Current [A]", enter the value.
 - Modbus:
(see "Tab. 7-6", pg. 7-14).
3. Enter maximum allowed battery current change in A/ms.
 - User interface:
Under "Battery Current Slope [A/ms]", enter the value.
 - Modbus:
(see "Tab. 7-6", pg. 7-14).

Start transmission of power

4. Start transmission of power.

- User interface:
For "Activate Power Stage [bit]", enter = "1".
Press key ↵.
- Modbus:
For the address for power operation, set bit = 1(see "Tab. 7-6", pg. 7-14).

Stop transmission of power

5. To stop the transmission of power:
 - User interface:
For "Activate Power Stage [bit]", enter = "0".
Press key ↵.
 - Modbus:
For the address for power operation, set bit = 0(see "Tab. 7-6", pg. 7-14).

Starting/stopping power transmission for other DC-DC modules

6. Starting/stopping power transmission for other DC-DC modules
 - Select another DC-DC module (via user interface or slave address via Modbus) and perform the previous steps again.

or

- To switch on all DC-DC modules simultaneously:
 - User interface:
For "Slave Module Selection" enter "0".
 - Modbus:
Enter the number of the slave to be addressed = "0" (see "Tab. 7-6", pg. 7-14).
- Start transmission of power.

5. Displaying and resetting messages

5.1 User interface: displaying and resetting messages

Displaying messages

If a message is pending, the sidebar is colored orange or red. If only warnings are pending, the sidebar is orange. If at least one alarm is pending, the sidebar is colored red.

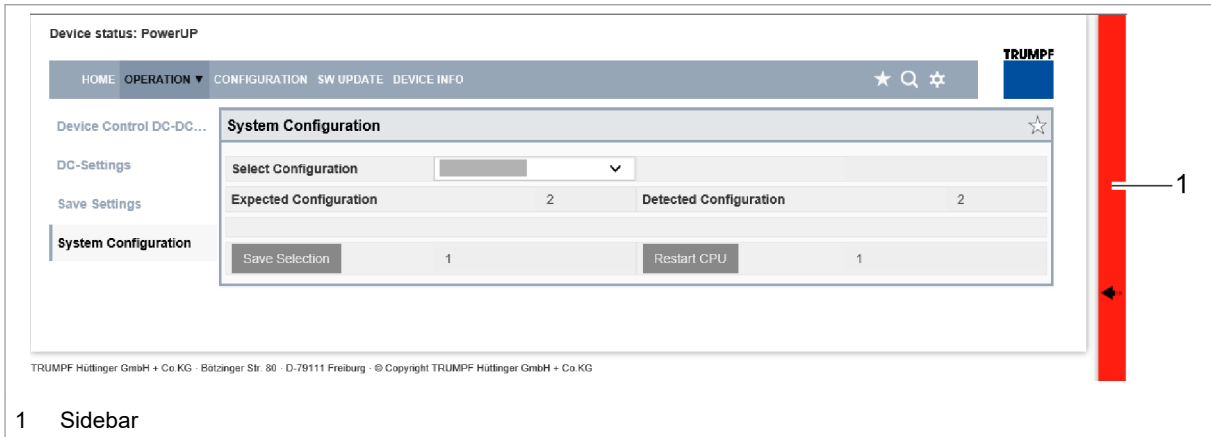

1 Sidebar

Sidebar, collapsed

Fig. 7-7

1. Click on the sidebar to display the messages.

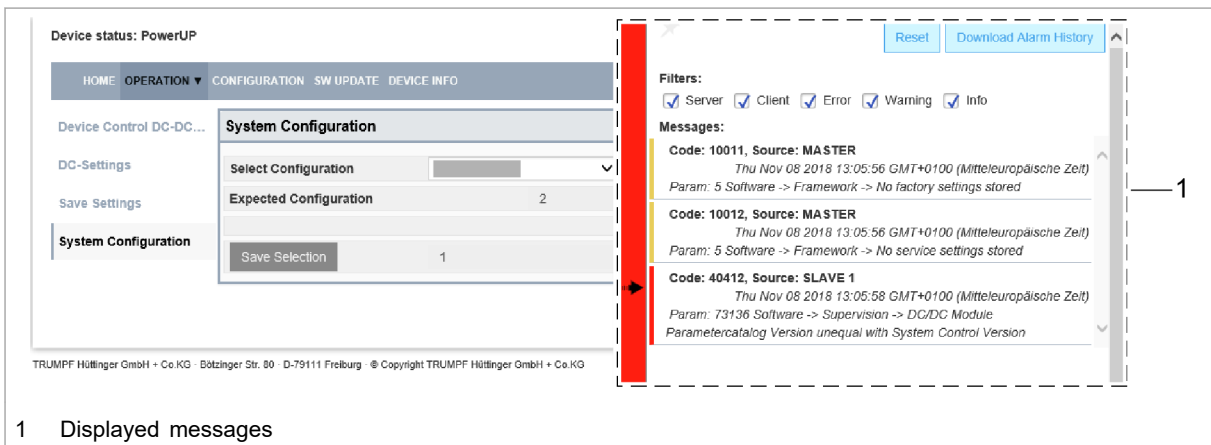

1 Displayed messages

Sidebar, expanded

Fig. 7-8

A message consists of 3 components: "Code" (message number), "Source" (originator) and message text.

The module that has caused the message is indicated by the description and number in the "Source" field.

MASTER = System control

SLAVE = AC-DC module and/or DC-DC module

Each slave number has 4 digits. The first 2 digits stand for the slaves (AC-DC modules) connected to the system control, and the 3rd and 4th digits stand for the subslaves (DC-DC modules).

Example:

Source: Slave 0204 → A subslave 04 (DC-DC module) is connected to slave 02 (AC-DC module). DC-DC module number 4 has caused the message.

If TRUMPF Service is to be contacted, it is recommended to note down the message number.

- Download alarm list**
2. To download a list of all alarm messages that have occurred:
 - Press the "Download Alarm History" button.
 - Save as a csv file.

- Reset messages**
3. Reset messages:
 - Select >Operation >Device control DC-DC mode.
 - For "Reset alarm [bit]", enter = "1".
 - Press key ↓.
 - or
 - If messages are displayed, press "Reset".

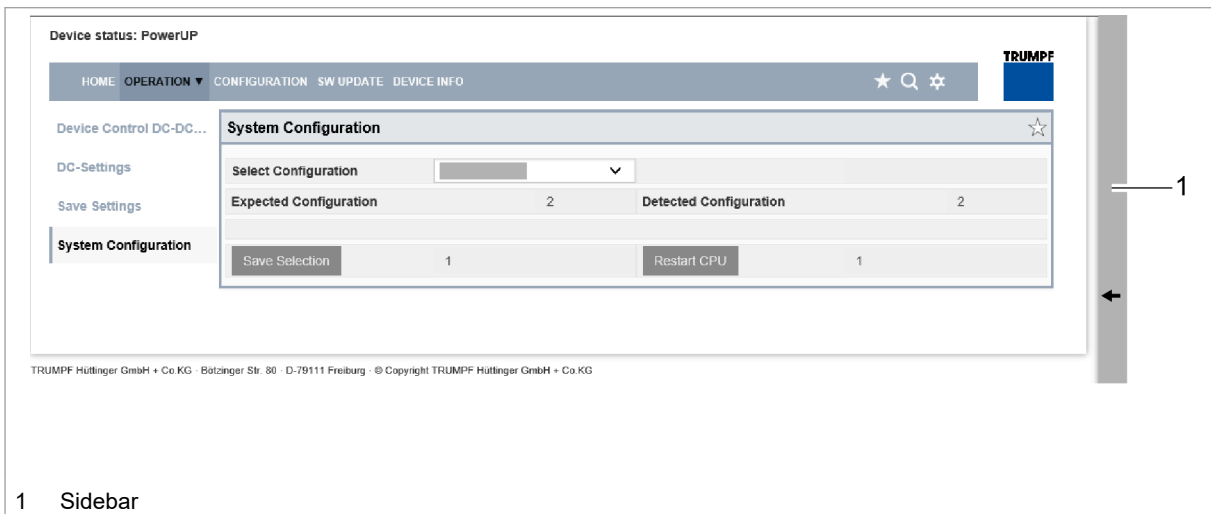

1 Sidebar, collapsed, no messages

Fig. 7-9

The sidebar turns white again. All messages are reset.

If the message is not reset:

- If MASTER is displayed under "Source", enter 0 under "Slave module selection". All messages are reset, including the messages from the master (system control).
- If SLAVE 1 is display under "Source", enter 1 under "Slave module selection" in order to reset only the messages from slave 1 and its subslaves.

5.2 Modbus: displaying and resetting messages

There are three different types of message: alarm, warning and info.

The number of pending messages can be queried by message type and the message numbers read out. The messages can then be assigned to the DC-DC module that caused the message.

Displaying the number of pending messages

1. Read out the number of current alarm/warning/info messages that have occurred on the entire system (see "Tab. 7-5", pg. 7-13).

Slave address = 0

The number of all messages that occurred in the system is output.

2. Read out the number of current alarm/warning/info messages that have occurred on an individual DC-DC module.

Slave address = 1 to n

The number of messages that occurred at this DC-DC module is output.

Reading out message numbers

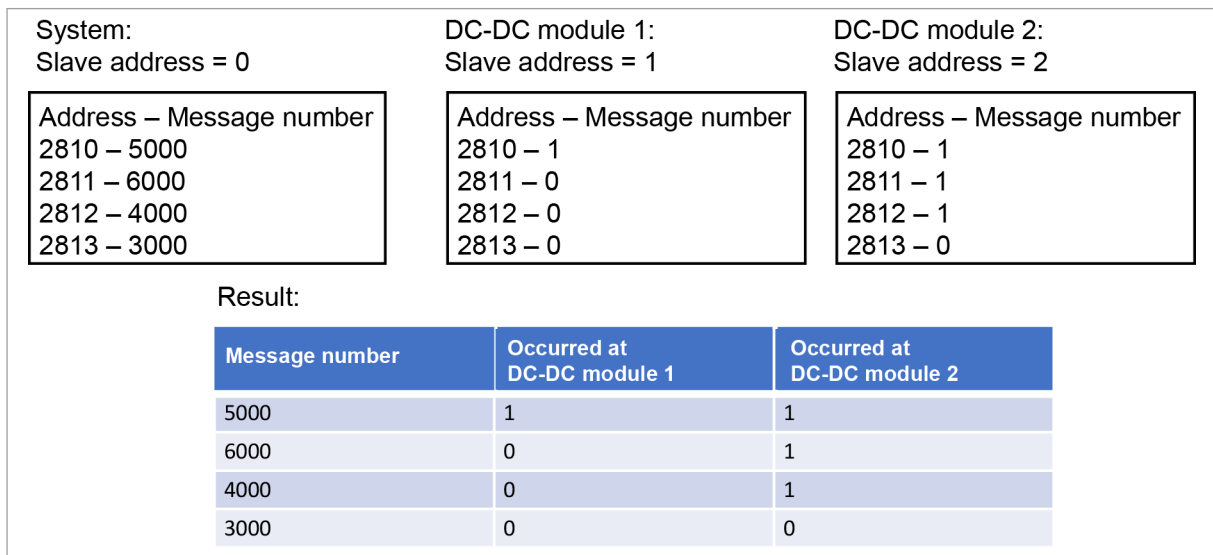

Read out messages and assign to respective DC-DC module

Fig. 7-10

3. Read out message numbers (alarm/warning/info messages 1 to 20) that have occurred on the entire system.

Slave address = 0

All message numbers of the messages that occurred in the system are output in an overview list. The message numbers are output in the order in which they occurred.

4. Read out message numbers (alarm/warning/info messages 1 to 20) that have occurred on an individual DC-DC module.

Slave address = 1 to n

Output for each DC-DC module are the messages that occurred in the system and were caused by the respective DC-DC module. The address represents the message number that was stored there in the overview list (slave address = 0). The value stored at this address can be 0 or 1.

Value = 1, this message is pending at the DC-DC module.

Value = 0, this message is not pending at the DC-DC module.

- Reset messages**
5. Reset all messages (see "Tab. 7-6", pg. 7-14):

- Slave address = 0

- Value = 1

All messages are reset. No further messages are pending.

If the cause of a message persists, this message is displayed again.

6. Overload

To permit load peaks when starting up motors or when starting devices, the AC-DC modules can be operated in overload operation. This method of operation is permissible only for a short time and is regulated accordingly by the system.

The overload is monitored and regulated separately for each phase.

6.1 Operating with overload

To permit load peaks when starting up motors or when starting devices, the DC-DC modules can be operated in overload operation. To maintain the life span of the modules, this method of operation is permissible only for a short time and is regulated accordingly by the system.

Note

Overload operation is only possible in the overload temperature range from -5°C to 40°C and with a battery voltage > 30 V.

1. To select the same settings for all DC-DC modules: set the number of the slave to be addressed = 0.
2. Increase maximum values for current.

Increase battery current to max. ± 250 A.

- User interface:
>Operation >DC Settings "DC Current Settings" "Maximum Battery Current [A]".
- Modbus:
(see "Tab. 7-6", pg. 7-14)

3. Increase maximum values for power.

Increase battery power to max. 12000 W.

- User interface:
>Operation >DC Settings "DC Power Settings" "Maximum Terminal Power [W]"
- Modbus:
(see "Tab. 7-6", pg. 7-14)

4. Start transmission of power.

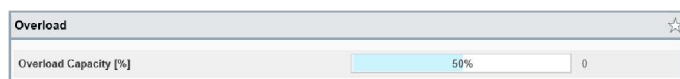

Status bar for the overload capacity (user interface)

Fig. 7-11

As soon as a higher battery current and battery power that is higher than the nominal power is called, the system can supply this for a certain time span.

During overload operation, the overload capacity is reduced continuously. The still remaining overload capacity is displayed on the user interface in percent in the form of a status bar. The actual value for the overload capacity can be queried via Modbus (see "Tab. 7-7", pg. 7-15). As soon as the overload capacity has dropped to "0%", only operation at nominal power is possible.

Once the system has cooled long enough, the overload capacity increases again and overload operation is possible again.

6.2 Examples: Reduce and then again increase overload capacity

Reduce overload capacity from 100% to 0%

The overload capacity drops from 100% to 0% if the system is operated at overload with:

- A battery current or a battery power between 100% and 125% (the higher value is relevant).
For 10 minutes.
or
- A battery current or a battery power between 125% and 150% (the higher value is relevant).
For 1 minute.

Increase overload capacity again from 0% to 100%

The overload capacity increases again from 0% to 100% if the system is operated under normal load with:

- A battery current or a battery power < 90%.
For 20 minutes.
or
- A battery current or a battery power < 80%.
For 10 minutes.

7. Actual values

7.1 Display actual values

Note

Some actual values can only be displayed if a specific DC-DC module was selected. To display the actual values for battery voltage, DC link voltage and temperature, the number of the slave to be addressed must be specified.

If the number of the slave to be addressed is set = 0 (overview of the entire system), 0 is displayed for these actual values.

1. Either
 - To display the actual values for one DC-DC module: enter the number of the slave that is to be addressed.

or

- To display the actual values for the entire system: set the number of the slave that is to be addressed = 0.
2. Displaying the current battery values.
 - User interface:
Select *>Operation >Device Control DC-DC*.
Read the actual values in the "Status Battery Interface" area.
 - Modbus:
Read actual values (see "Tab. 7-7", pg. 7-15).
3. Display currently intervening regulator.

The following regulators can be active: Pmax, max. charging current, max. battery voltage and min. battery voltage.

- User interface:
Select *>Operation >Device Control DC-DC Mode*.
Read off the active regulator in the "Status Battery Interface" area under "Current Limiting Status".
 - Modbus:
Read status of current limiting (see "Tab. 7-7", pg. 7-15).
4. Display current DC link voltage.
 - User interface:
Select *>Operation >Device Control DC-DC*.
Read the actual value in the "Status DC Link" area.
 - Modbus:
Read actual value (see "Tab. 7-7", pg. 7-15).
5. Display the current temperature.



-
- User interface:
Select >Operation >Device Control DC-DC.
Read the actual value in the "Device Temperature" area.
 - Modbus:
Read actual value (see "Tab. 7-7", pg. 7-15).

8. Process set values

8.1 Set process set values

1. Either

- To set the set values for a single DC-DC module: Enter the number of the slave in the "Slave Module Selection" area under "Slave Number".

or

- To uniformly set the set values for all DC-DC modules: set the "Slave Number" = 0.

2. Set the lower and upper limit up to which the battery is discharged or charged, respectively.

- User interface:

Select >Operation >DC Settings.

Set the following in the "DC Settings" area:

For "DC Voltage Limits", enter:

"Minimum Battery Voltage [V]": lower limit, up to which the battery is discharged.

"Maximum Battery Voltage [V]": upper limit, up to which the battery is charged.

- Modbus:

(see "Tab. 7-6", pg. 7-14)

3. Set the lower and upper alarm limit.

- User interface:

Enter the limit values for the DC-DC module in the "DC Voltage Error Thresholds" area:

For "DC Voltage Limits", enter:

"Minimum Battery Voltage Threshold [V]": lower limit, up to which the battery is discharged.

If this value is not met (e.g., due to short circuit of the battery), the TruConvert System Control generates an alarm message.

"Maximum Battery Voltage Threshold [V]": upper limit, up to which the battery is charged.

If the value is exceeded, the TruConvert System Control generates an alarm message.

- Modbus:

(see "Tab. 7-6", pg. 7-14)

- Select the values so that they lie outside of the "DC Voltage Limits" control range.

4. Enter limit values for the charging and discharging current.

- User interface:
Set the following in the "DC Current Settings" area:
"Maximum Battery Charge Current [A]": maximum battery charging current.
"Maximum Battery Discharge Current [A]": maximum battery discharging current
 - Modbus:
(see "Tab. 7-6", pg. 7-14)
5. Enter limit values for the power output/power draw.
- User interface:
Set the following in the "DC Power Settings" area:
"Maximum Terminal Power [W]": maximum power.
 - Modbus:
(see "Tab. 7-6", pg. 7-14)
6. Enter current-voltage characteristic curve (see "Fig. 3-1", pg. 3-4).
- User interface:
Set the following in the "Voltage Current Characteristics (VCC) Settings" area:
"VCC Start Point Current [A]": battery current at minimum battery voltage.
"VCC End Point Current [A]": battery current upon reaching "VCC End Point Voltage [V]".
"VCC End Point Voltage [V]": battery voltage.
 - Modbus:
(see "Tab. 7-6", pg. 7-14)

The charging and discharging current of a battery are set as a function of the voltage with the "VCC-Settings". The values must be selected so that they lie in the shaded part of the VCC curve.

The dashed line shows the "VCC-Settings" on delivery (default values).

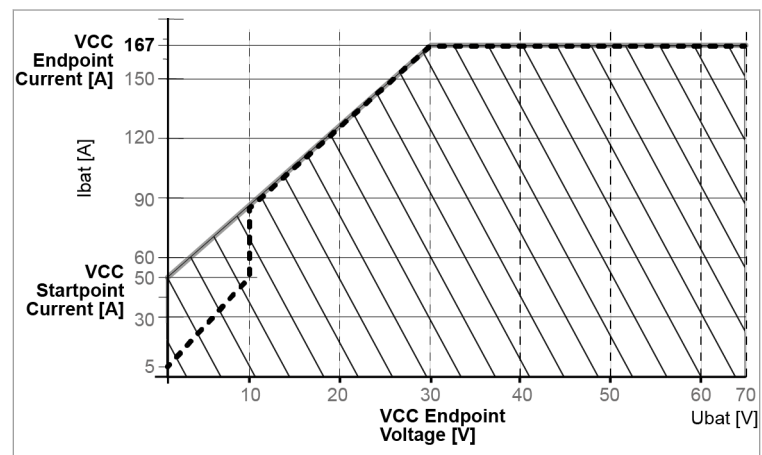

VCC curve

Fig. 7-12

9. Data backup

9.1 Saving data

All general settings that were made under *>Operation >DC-DC module settings* with "Slave number" = "0" can be stored in the device and are retained following a restart as well as after switching the device off and back on again.

The general settings can be exported and then imported into another device.

Individually generated settings for single DC-DC modules ("Slave number" = "1" to "n") cannot be stored.

Conditions

- Operation via web-based user interface
 - Settings to be stored were entered under *>Operation >DC-DC module settings* with "Slave number" = "0".
1. Select *>Operation >Save settings*.
 2. In the "Save settings" area under "Save settings", select "Save current settings" to save the current settings in the TruConvert System Control.
 3. In the "Save settings" area, select "Restore factory settings" to again restore the factory settings.
 4. Press "Export settings" to save the current settings as a CSV file on a hard drive of the PC.

If the data is displayed in the browser, instead of being saved as CSV file:

- Select and copy all text (<Ctrl> + <A>, <Ctrl> + <C>).
 - Open a text editor.
 - Insert data (<Ctrl> + <V>).
 - Place the cursor at the end of the file (after: "END;;;"). Press the enter key ↵ once to insert a new line.
 - Save data as file with extension "csv" on the PC.
5. Press "Select files" in the "Import settings" area to search for and select a CSV file on a hard drive of the PC.
 6. In order to load the selected CSV file to the system control and restart the system control:
 - Press "Update".
 - Select *>Operation >System configuration* and press "Restart CPU".Or switch the 24 V supply voltage off and on again.

10. System configuration

If the combination of devices connected to the system control is changed, the new system configuration must then be entered via the web-based user interface.

10.1 Setting the system configuration

Conditions

- Operation via web-based user interface
 - Devices (AC-DC module, DC-DC modules) are connected to the system control
1. To switch on the system control and the modules: switch on the 24 V supply voltage.

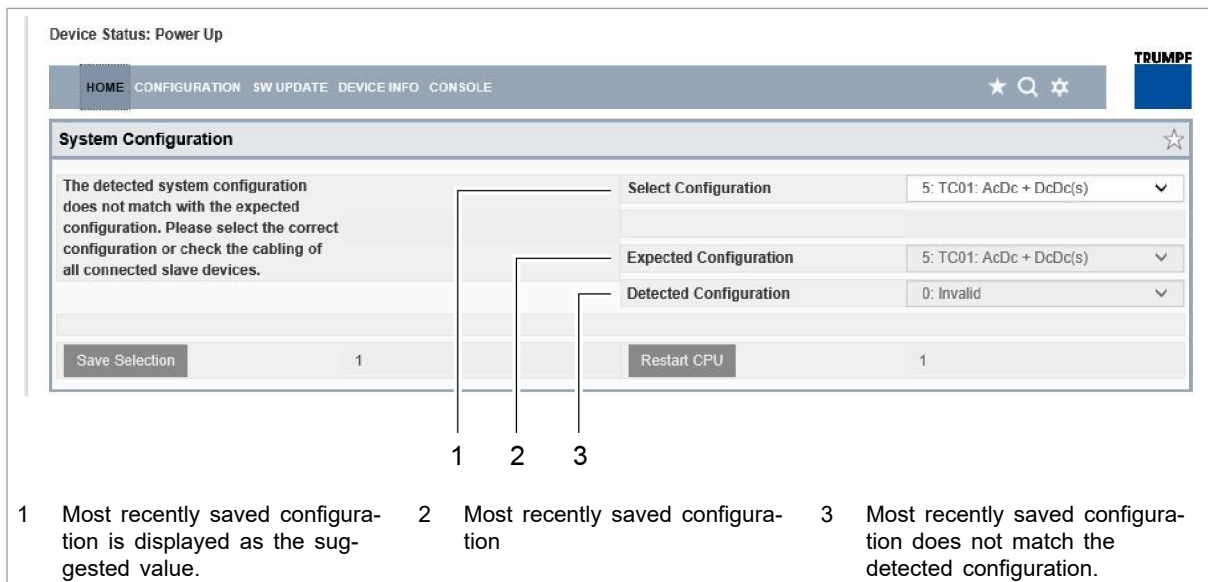

Input screen "System Configuration"

Fig. 7-13

The input screen "System configuration" is displayed.

The connected devices do not match the expected configuration, i.e. the most recently saved configuration.

Status LEDs on the system control: All 3 LEDs flash synchronously.

Status LEDs on the DC-DC module: The green and red LEDs light up and the yellow LED flashes.

2. In "Select configuration", select the present system configuration:

- 0: No configuration
This configuration only occurs in the event of an error, e.g., if there is no connection to the modules (check cables) or if an incorrect module type was detected (check alarm messages).
 - 1: Simulator
The system control alone is used and connected modules are simulated.
 - 2: DC-DC only
Only DC-DC modules are connected to the system control.
 - 3: n (AC-DC + m DC-DC)
AC/DC and DC/DC modules are connected to the system control.
3. To save the selection: press "Save selection".
 4. To restart the TruConvert System Control: press "Restart CPU".

1 Display of the current device status

2 Main operating parameters (start page)

3 Device configuration (time and network settings)

4 Software update

5 Device identification (display only)

6 Submenu

7 Sidebar (alarm, warning and event messages)

Start screen

Fig. 7-14

The system is ready for operation: It is in "Idle" mode and the start screen is displayed.



The system control balances the set system configuration with the actually connected modules. If both values match, the start screen is displayed.

If the set system configuration ("Expected configuration") differs from the automatically detected system configuration ("Detected configuration"), the input screen "System configuration" is displayed again and a message output. Press sidebar (7) to display the messages.

11. System control

11.1 Setting the system time

User interface As soon as the device is connected to the PC, the local time of the PC is converted to UTC and adopted in the system control as system time.

In addition, adoption of the system time can also be triggered manually.

1. In the sidebar, click on "Settings" ✨.

The sidebar is displayed.

2. To adopt the system time from the PC for the device, press "Synchronize to local computer".

Then press "Submit time and date".

The system time of the PC is displayed on the user interface and transferred to the device.

- Modbus**
3. Enter new values for date and time (see "Tab. 7-3", pg. 7-12).

11.2 Changing network settings

Changing the IP address

Note

The IP address can only be changed via the user interface.

1. Select >CONFIGURATION >Server Configuration.
2. Enter new values in "IP Adresse".

(IP address of the TruConvert System Control on delivery: 192.168.1.2)

3. Note the new IP address so as to be able to access the system control via the user interface or via Modbus.
4. Press "Submit IP Configuration".

The network settings are transferred to the system control.

Using the Reset button to reset the IP address

If the IP address of the device was changed and is not known, the IP address can be reset to the factory settings with the help of the Reset button.

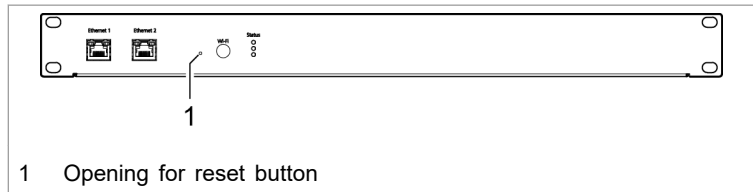

Reset button on the system control

Fig. 7-15

5. Insert a small pen tip or piece of wire into the opening for the Reset button and press and hold down the Reset button for 3 seconds.
6. Switch 24 V supply voltage off and back on again to restart the device.

The IP address of the device was reset.

Tip

To reset the device including all customer parameters to the factory settings: press and hold down the Reset button for 10 seconds.

Changing the IP subnet and gateway

7. To change the network settings:
 - User interface:
Enter new values for "IP Subnet Mask", "IP Host" and "IP Gateway".
Press "Submit IP Configuration".
 - Modbus:
Enter new values for IP subnet and IP gateway (see "Tab. 7-3", pg. 7-12).



The network settings are transferred to the system control.

12. Software update

12.1 Perform software update

Conditions

- Operation via web-based user interface
- Zip file with new software stored on PC.

1. Select *>SW update* .
2. In the "Software update" area, press the  button and open the zip file.
3. Press the  button to upload the zip file.

If the update was performed successfully, the system control automatically performs a restart.

13. Device information

13.1 Displaying device information

1. Select `>DEVICE INFO`.
2. To display the information for a single DC-DC module: Enter the number of the slave in the "Slave Module Selection" area under "Slave Number".
3. In the "Serial Numbers" area, read the serial number for the selected DC-DC module under "DC-DC Module Serial Number".
4. In the "Software Package" area, read the details on the installed software package.
Relevant details are: "Integration Level" and "Buildnumber".
5. The software version on the system control can be read in the "Software System Control" area (part of the "Software Package").
6. The software version for the selected DC-DC module can be read in the "Software DC-DC Module Control" area (part of the "Software Package").

Tip

The serial numbers of the system control and the modules can also be queried via Modbus (see "Tab. 7-4", pg. 7-12).

14. Favorites

14.1 Creating a favorites page

Individual areas on the user interface can be marked as favorites and displayed on a favorites page.

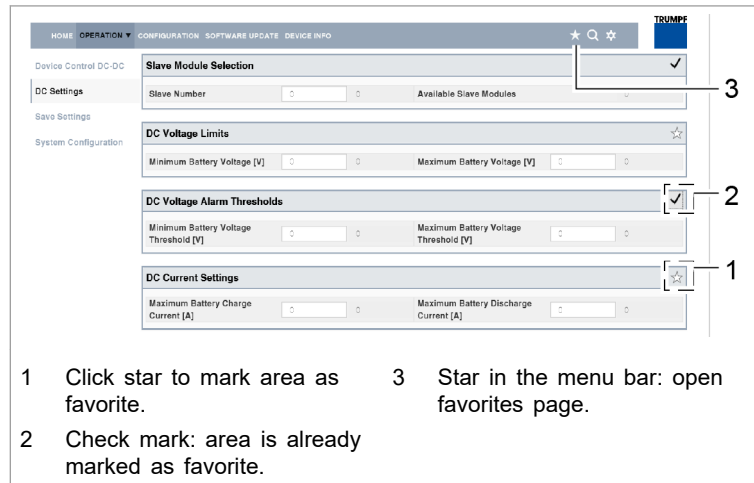
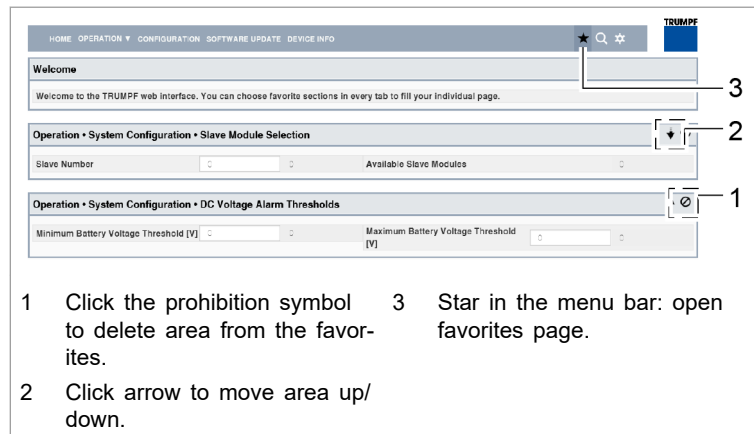

Fig. 7-16

1. Click on the star (1) in frequently needed areas.
2. To display the created favorites page: click on the star at the top in the menu bar (3).



Favorites page

Fig. 7-17

3. To edit the favorites page further:
 - Click the prohibition symbol (1) to delete an area from the favorites.
 - Click the arrow (2) to move an area up/down on the favorites page.

15. Search

15.1 Searching

It is possible to search for keywords on the user interface.

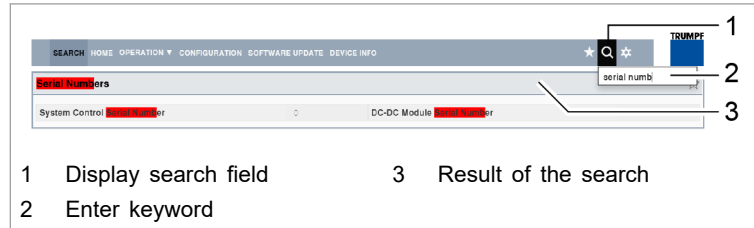

Search

Fig. 7-18

1. Click on the magnifying glass at the top in the menu bar (1).
2. Enter the keyword in the search field (2).

Press key ↵.

All areas that contain the search term are displayed.

16. State diagram

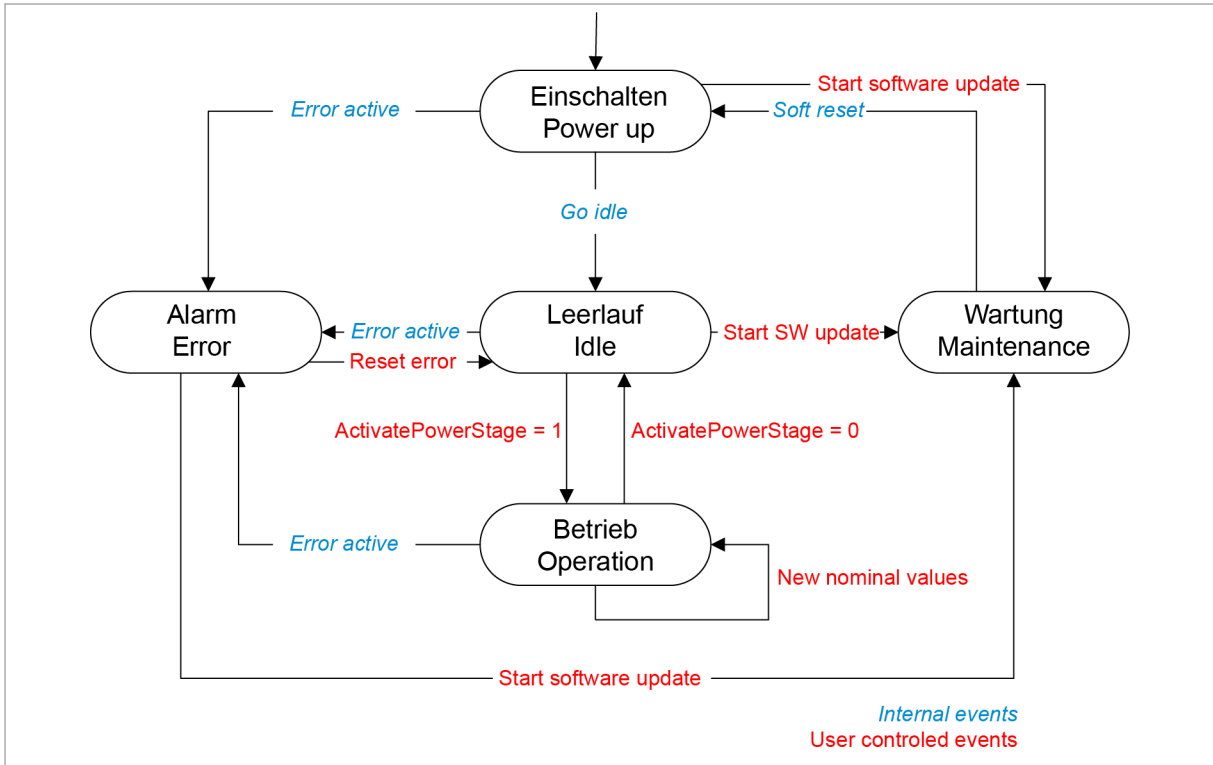

State machine

Fig. 7-19

Chapter 8

Maintenance

1	Maintenance work	8-2
1.1	Periodic check of the environmental conditions	8-2
1.2	Exchanging fans	8-2
1.3	Performing software updates	8-2
1.4	Cleaning	8-2

1. Maintenance work

Note

Housing must not be opened

The housing of the generator is sealed with stickers. Damage to the seals or the opening of the housing will invalidate the warranty.

1.1 Periodic check of the environmental conditions

In the event of poor environmental conditions, e.g. air with oil, dust and conductive parts, the fans may draw in particles that damage the module. The environment should therefore be kept as clean as possible.

1.2 Exchanging fans

The operating hours of the fan are counted. After the allowed running period is up, the module outputs a message.

TRUMPF recommends replacing the ventilator after an operation lifetime of 6 years.

- Only have fans exchanged by TRUMPF personnel or trained staff.

1.3 Performing software updates

Software updates can only be made via the user interface.

- Have software updates for the PCS performed by TRUMPF personnel only; if you perform the updates yourself, consult with TRUMPF personnel beforehand.

1.4 Cleaning

If necessary, clean the module with a dry cloth.

Chapter 9

Troubleshooting

1	Fault indication and messages	9-2
1.1	Fault indication with the LEDs	9-2
2	Messages	9-3

1. Fault indication and messages

Faults are displayed at different positions:

- Status LEDs on the DC-DC module.
- Status LEDs on the TruConvert System Control.
- On the web-based user interface.
- Via the Modbus.

1.1 Fault indication with the LEDs

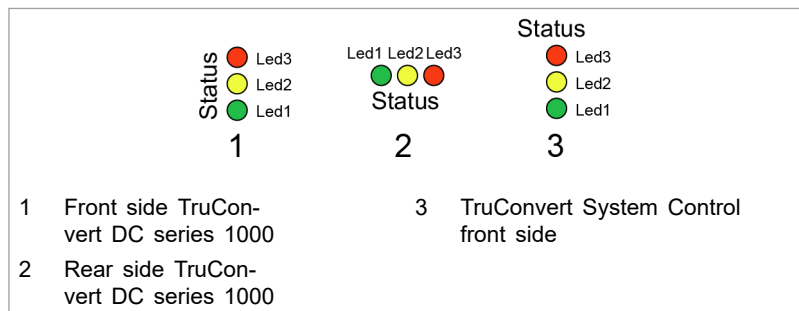

Status LEDs

Fig. 9-1

LED	Errors
1 (green)	off
2 (yellow)	off
3 (red)	Flashing

Display of the status LEDs in the event of a fault

Tab. 9-1

2. Messages

A distinction is made between alarm messages and warning messages.

Alarm message Power operation is automatically shut off if serious errors occur. The PCS switches to the alarm state and outputs an alarm message. Power operation can only be restarted after the cause of the alarm has been removed and the alarm message has been reset (see ["State diagram"](#), pg. 7-38).

Warning message In case of less severe faults, the power operation is not interrupted, but a warning message is issued.

Display of alarm and warning messages The messages that are output always consists of an alarm or warning number and a message text.
When operating the device with the web-based user interface, the alarm and warning numbers are displayed together with the message text. In case of control with Modbus, only the numbers and no text are transmitted.

Resetting alarm and warning messages ([see "Displaying and resetting messages"](#), pg. 7-18)

List of alarm and warning messages The following tables show the most important alarm and warning messages, with notes on error causes and how to correct them.
If a message reappears repeatedly after resetting and restarting the device, please contact TRUMPF Service.
If a message appears whose number is not listed in the table, please also contact TRUMPF Service.

Alarm messages

Number	Message	Caused by
40302	BMS communication timeout has occurred	System control
40303	RS-485 communication alarm	System control
40304	No slave module was found, please check RS-485 connection(s)	System control
40305	Number of or combination of connected slave types not supported	System control
60090	Battery overvoltage	DC-DC module
60093	DC link overvoltage	DC-DC module
60102	DC link voltage to low for operation	DC-DC module
60700	Auxiliary supply overvoltage	DC-DC module
60142	Battery undervoltage	DC-DC module
60703	Auxiliary supply undervoltage	DC-DC module
60145	Wrong polarity on DC terminal detected	DC-DC module
60132	RS485 communication alarm	DC-DC module
60129	Battery voltage under threshold setting	DC-DC module
60150	Battery voltage over threshold setting	DC-DC module
60168	Ambient temperature over allowed range	DC-DC module
60186	Ambient temperature under allowed range	DC-DC module
60192	Fan defective or stuck	DC-DC module

Alarm messages

Tab. 9-2

Warning messages

Warning no.	Text
TruConvert System Control	
10016	Powerfail of 24 V auxiliarsupply has been detected
TruConvert DC 10xx	
11000	battery voltage < minimum reference or battery voltage > maximum reference

Warning messages

Tab. 9-3